

Z Key Exchange Box

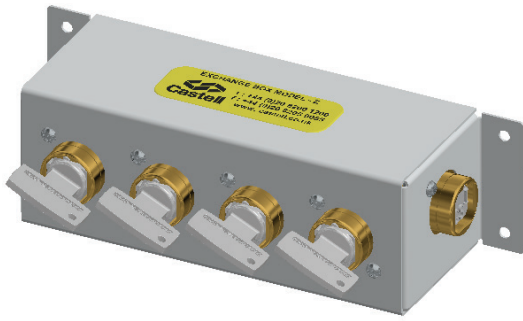

The Z key exchange box is designed to enable the release of keys by insertion of an initial key. The Z box is suitable for releasing up to five keys non sequentially once the isolation (end key) has been inserted and trapped. The requirement for this type of product usually arises due to there being multiple keys required than the initial isolation system supplies. The unit will generally be the link between the isolation locks and the access products. The Z box is supplied in an enclosure suitable for surface mounting.

OPERATION

Castell Key Exchange Boxes are used in various applications to control multi-door access to hazardous areas.

Z key exchange box, horizontal mount (1 key free - 4 keys trapped)

1 End key is free, 4 front keys trapped



While the isolation key is free, this is usually trapped in the power isolator, the access keys, positioned on the front, are trapped.

2 Insert and turn end key, then turn and release front keys in any order

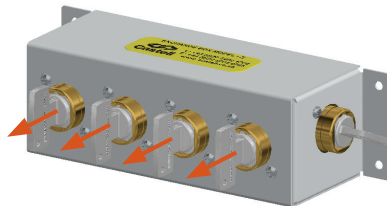

By inserting the isolation key the access keys are released in any order. Once the first access key has been removed the isolation key will be trapped. The access keys can then be used to access the protected area via access locks.

3 End key is trapped, 4 front keys are free



The isolation key remains trapped until all the access keys have been returned.

The Z key exchange box is available with up to five front keys and also in a vertical mounting version.

USAGE

Z key exchange boxes should be used to allow a safe access to potential hazardous and dangerous areas with one or more access points.

 The Z key exchange box is not designed for security purposes, such as access to a building.

No hazardous substances were used in the manufacture of this product.

INSTALLATION

The Z key exchange box should normally be mounted using suitable fasteners. Please refer to the drawing on page 4 for maximum and minimum mounting distance. The Z key exchange boxes are available in horizontal and vertical mounting versions.

 You must use M6 anti-temper stainless steel screws secured using threadlock set to a torque of 5 N/M.

 The Z key exchange box must be installed by a competent and qualified person who has read and understood these instructions. Please retain this document in your technical file.

 The manufacturer should be consulted when use in a corrosive environment is planned.

MAINTENANCE

Periodic visual checks should be carried out by the site manager/safety officer.

Do not lubricate lock barrel with oil or grease, use CK dry powder graphite if necessary.

 In case of defects being detected please contact your nearest Castell Support Department for further actions. Please see Contact section for contact details.

 The interlock must be inspected every 6 months. Safety checks should include ensuring the keys can only be removed in the correct safety operating conditions (see page 1).

TECHNICAL DATA

Temperature rating	Minimum: -40°C [-40°F] ice free for Q lock & FS lock type
	Maximum: 107°C [224,6°F] for Q lock type/140°C [284°F] for FS lock type or 288°C [550°F] upon request
Type of mounting	Surface mount using suitable fasteners
Weight	Brass: 1 kg for 2 lock portions, add 0.5 kg per additional portion
Material	Brass
B10d	2,500,000
Shock & vibration	EN 60068
PL rating	PLd

APPLICATION

The Z Key Exchange Box safety component is used as part of an integrated safety system.

A typical application of the Z Key Exchange Box is machine guarding with multiple access points to the hazardous area.

The key exchange box is used as a part of a safety system, which ensures a machine is shut down, before access to the hazardous area is allowed. The system involves a KS key switch for the electrical supply and typically more than one AI or AIE access interlocks for full body access.

The removal of the isolation key from the key switch isolates the electrical supply to the machine. This key is taken to the Z key exchange box to release the trapped keys. The released keys are used to gain access through the AIE access interlocks.

The machine cannot be restarted until all keys are returned to the Z key exchange box and the power isolation key is released and replaced in the KS key switch.

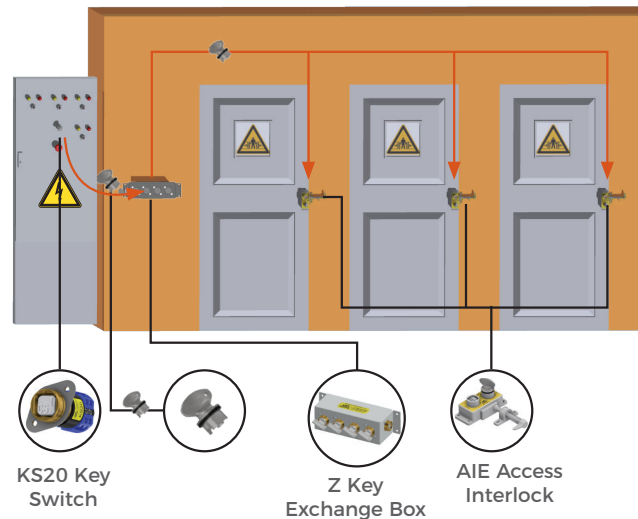

Z Key Exchange Box

DRAWING

Dimensions: in mm

Note: For safe mounting, use security screws

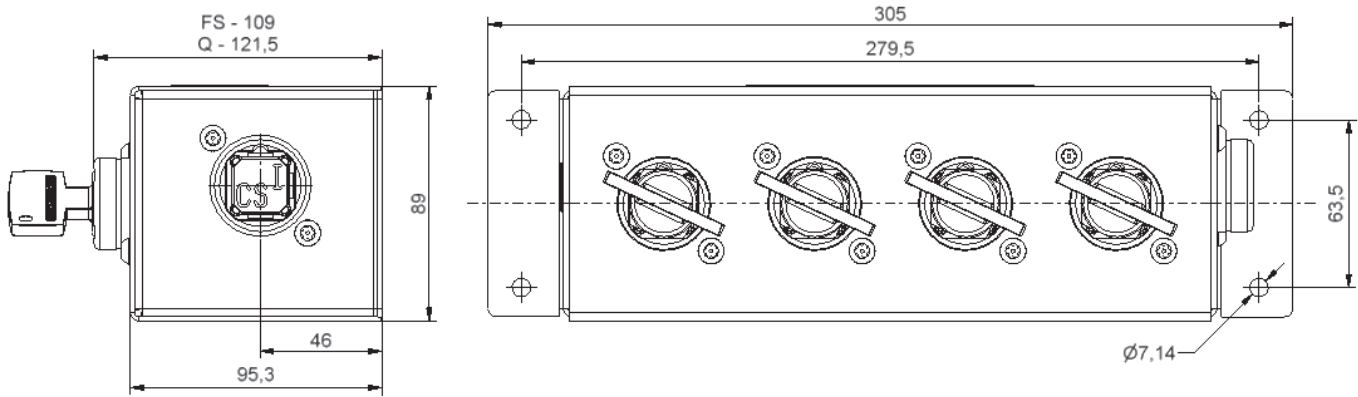

Z key exchange box, horizontal mount



ORDER INFORMATION

	Component type	1	2	3	4	5
Part number	Z					
Example	Z	FS	B	H	1	3
	6 A End lock symbol			7 B Front lock symbol(s)		

1	Lock portion type	FS ⁽¹⁾ / Q ⁽¹⁾
2	Material	B = Brass (standard)
3	Mounting	H = Horizontal V = Vertical
4	Number of end keys	1 (standard)
5	Number of front keys	Please specify (maximum = 5)
6	Lock portion symbol - End key	FS ⁽¹⁾ up to 3 characters / Q ⁽¹⁾ up to 6 characters
7	Lock portion symbol(s) - Front key(s), all to be advised separately	FS ⁽¹⁾ up to 3 characters / Q ⁽¹⁾ up to 6 characters

(1)	FS - Lock type Up to 3 characters	Q - Lock type Up to 6 characters
		

Special construction available upon enquiry

ACCESSORIES

	Product	Part number
	Flip Cap	FLIP-S

CONTACT INFORMATION

Castell Safety

The Castell Building, 217 Kingsbury Road, London, NW9 9PQ UK
t: +44 (0)20 8200 1200 | f: +44 (0)20 8205 0055 | e: sales@castell.com