

KLE Sliding Door Interlock

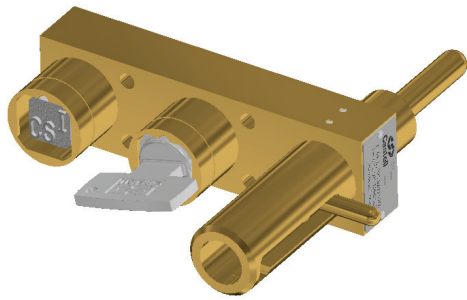

The KLE double key sliding door interlock is a one piece access interlock comprising of a main body and sliding bolt. The lock is designed to suit sliding doors of various sizes and thicknesses. The interlock is manufactured in brass and comes with the brass FS or Q lock type portions and is ideal for use in dry, non-corrosive environments where the lock is subject to medium to heavy use. Typical industries using the KLE lock are automotive and steel production. The KLE door interlock is available in a double key or exchange key condition.

OPERATION

The Castell KLE sliding door interlock range is used in machine guarding applications control access to hazardous areas.

KLE bolt interlock, exchange key condition

- 1** Key A is free, while key B is trapped and bolt is extended.



A B

While the side bolt is extended and key B is trapped, key A is free. The door is locked closed.

- 2** Insert and turn key A and then retract the bolt. Turn and release key B.



A B

Inserting and turning key A in the bolt interlock enables you to rotate key B, releasing the mechanism. This will trap key A into the lock. Key B can now be taken by the personnel to the machine area.

- 3** Key B is free, key A is trapped and bolt is retracted.

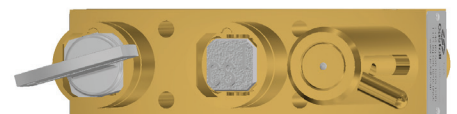

A B

Key A stays trapped until the door is open and key B returned to the KLE sliding door interlock.

KLE bolt interlock, double key condition

- 1** Key A and key B are free, bolt is extended.



A B

While the side bolt is extended, key A and B are free. The door is locked closed.

- 2** Insert and turn both keys and then retract the bolt.

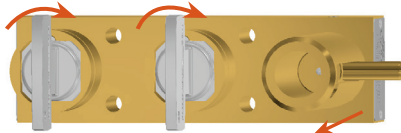

A B

Inserting and turning the keys will allow the bolt to retract. The door can now be unlocked.

- 3** Both keys are trapped, bolt is retracted.



A B

The keys stay trapped as long the door is opened and bolt is retracted.

The length of the bolt can be varied to suit the application but travel of the bolt is always 50.08 mm.

USAGE

The KLE sliding door lock should be used to allow safe control of sliding doors.

 The KLE lock is not designed for security purposes, such as access to a building.

No hazardous substances were used in the manufacture of this product.

INSTALLATION

The housing of the KLE sliding door lock should normally be mounted to a door using suitable fasteners (please refer to drawing on page 4 for more details).

 **IMPORTANT:** The interlock should be mounted using anti-tamper fasteners to prevent unauthorised removal.

 The KLE sliding door lock must be installed by a competent and qualified person who has read and understood these instructions. Please retain this document in your technical file.

 Force required to shear lock bolt is 19 KN.

 You must use M6 anti-tamper stainless steel screws secured using threadlock set to a torque of 5 N/M.

MAINTENANCE

Periodic visual checks should be carried out by the site manager / safety officer.

Do not lubricate lock barrel with oil or grease, use CK dry powder graphite if necessary.

 In case of defects being detected please contact your nearest Castell Support Department for further actions. Please see Contact section for contact details.

 The interlock must be inspected every 6 months. Safety checks should include ensuring the keys can only be removed in the correct safety operating conditions (see page 1).

TECHNICAL DATA

| | |
|------------------------------|---|
| Temperature rating | Minimum: -40°C [-40°F] ice free for Q & FS lock type |
| | Maximum: 107°C [224,6°F] for Q lock type/140°C [284°F] for FS lock type |
| Type of mounting | Surface mount using suitable fasteners (please refer to drawing on page 4 for more details) |
| Weight | Brass: 0.7 kg |
| Material | Brass |
| B10d | 2,500,000 |
| Shock & vibration | EN 60068 |
| PL rating | PLd |

APPLICATION

The KLE bolt interlock safety component is used as part of an integrated safety system, typically in machine guarding applications.

The power supply to the system is switched on and the access door to the hazardous area is locked closed.

The removal of the isolation key in the KS20 unit, isolates the electrical supply to the LV Panel. The key is then used to unlock the KLE sliding door interlock on the sliding door. This will release the second key (key B), which can be taken by personnel into the machine area.

The power cannot be switched on until key B is returned to the access interlock, the door is closed, the bolt and key B are trapped in the KLE unit and key A returned to the KS20.

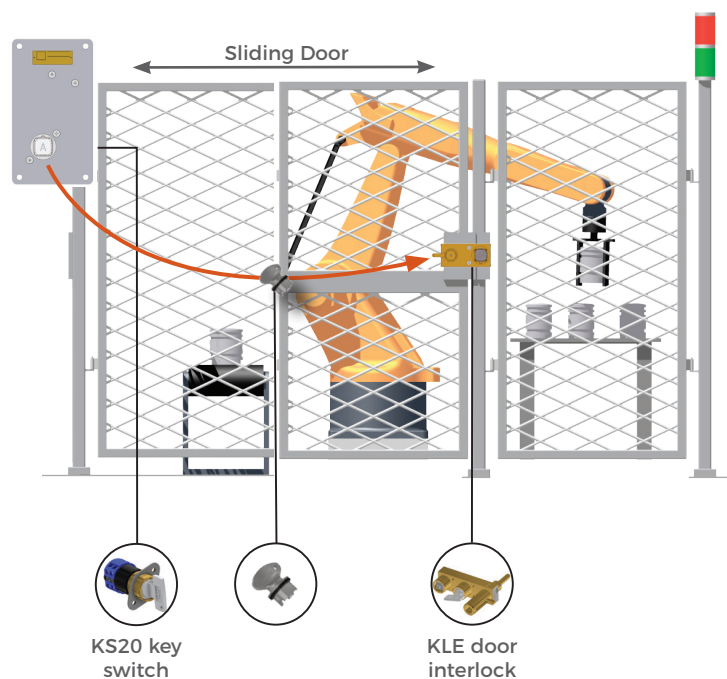

KLE Sliding Door Interlock

DRAWING

Dimensions: in mm

Note: For safe mounting, use security screws

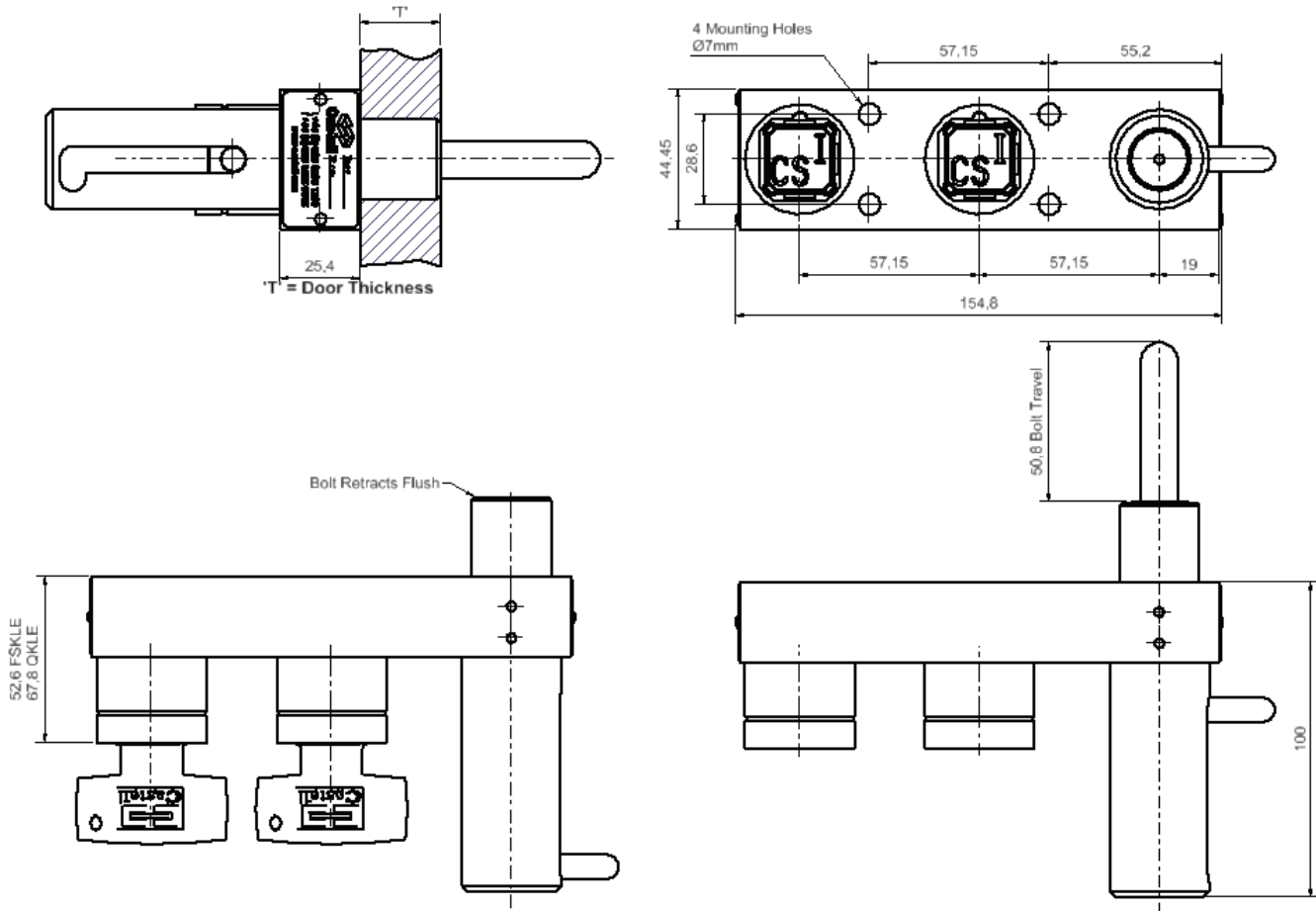

ORDER INFORMATION

| | | | | | | | | |
|-------------|-----------------------|----------|----------|----------|----------|----------|----------|----------|
| | Component type | 1 | 2 | 3 | 4 | 5 | 6 | 7 |
| Part number | KLE | | | | | | | |
| Example | KLE | FS | B | 1 | E | 50.8 | 4 | 9 mm |

8 **A** Isolation key symbol
(exchange key condition)

9 **B** Personnel key symbol (adjustment to bolt)
(exchange key condition)

| | | |
|----------|--|--|
| 1 | Lock portion type | FS ⁽¹⁾ / Q ⁽¹⁾ |
| 2 | Material | B = Brass (standard) |
| 3 | Number of secondary lock portions | 1 (standard) |
| 4 | Key condition | E = Exchange key condition / D = Double key condition (sequential removal of all keys) |
| 5 | Bolt length | 50.8 mm (standard) |
| 6 | Form | 1 / 2 / 3 / 4 ⁽²⁾ |
| 7 | Door thickness | Please advise |
| 8 | Lock portion symbol: Isolation key (for exchange key condition) | FS ⁽¹⁾ up to 3 characters / Q ⁽¹⁾ up to 6 characters |
| 9 | Lock portion symbol: Personnel key (for exchange key condition) | FS ⁽¹⁾ up to 3 characters / Q ⁽¹⁾ up to 6 characters |

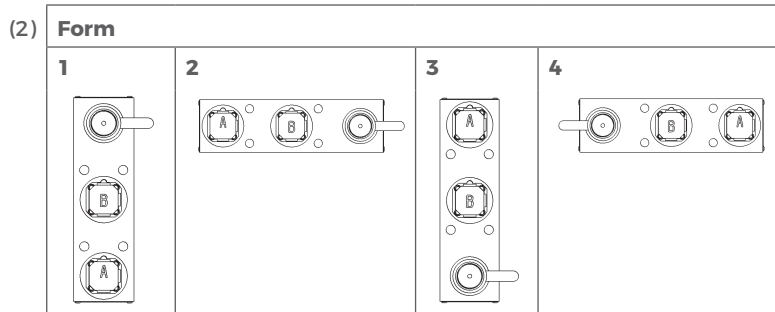
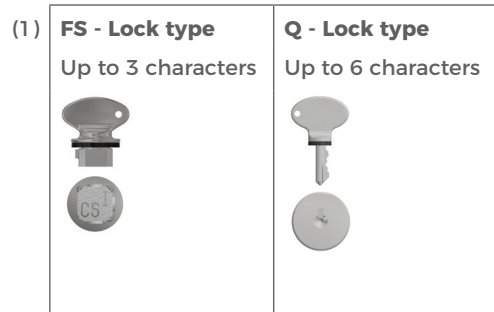

Special construction available upon enquiry

CONTACT INFORMATION

Castell Safety

The Castell Building, 217 Kingsbury Road, London, NW9 9PQ UK
t: +44 (0)20 8200 1200 | f: +44 (0)20 8205 0055 | e: sales@castell.com