



The KSP is a spring loaded version of the Castell K Lock using an internal spring to automatically extend the bolt to the full extend position when permitted to do so. The KSP lock is a key operated mechanical bolt interlock that is suitable for the control and locking of mechanisms. The standard unit comes with a 15.88 mm diameter bolt that is used to lock movement. The bolt is retracted against the spring by turning the key. This process enables automatic release of the key under certain permitted conditions.

OPERATION

The Castell KSP spring bolt interlock is used to inhibit movement of mechanical systems.

KSP bolt interlock, Form 4

1 Key is free, bolt is extended



While the side bolt is extended, the key is free. The mechanism is locked.

2 Insert and turn key to drive bolt



Inserting and turning the key retracts the bolt against the spring load. This will trap the key into the lock. The key must be held in this position until bolt movement is inhibited by the mechanism.

3 Key is trapped, bolt is retracted



The key stays trapped while the bolt is retracted. The bolt extends only when permitted to do so by the mechanism.

The travel of the bolt is always 19.05 mm. The key is free when the bolt is extended. Insertion and rotation clockwise of the key will retract the bolt. The key will be trapped in the bolt retracted position.

USAGE

The KSP spring bolt interlocks are used as a part of a safety system to allow safe control of mechanisms.

 The KSP bolt interlock is not designed for security purposes, such as access to a building. The KSP bolt interlock is not recommended to interlock access gates or doors. Please refer to AI access interlocks.

No hazardous substances were used in the manufacture of this product.

INSTALLATION

The housing of the KSP bolt interlock should normally be mounted to a panel using suitable fasteners. Please refer to drawing on page 4 for more installation details.

 **IMPORTANT:** The interlock should be mounted using anti-tamper fasteners to prevent unauthorised removal.

 The KSP bolt interlock must be installed by a competent and qualified person who has read and understood these instructions. Please retain this document in your technical file.

 Force required to shear lock bolt is 30K N for stainless steel and 19 KN for brass interlocks.

 You must use M6 anti-tamper stainless steel screws secured using threadlock set to a torque of 5 N/M.

 The manufacturer should be consulted when use in a corrosive environment is planned.

MAINTENANCE

Periodic visual checks should be carried out by the site manager / safety officer.

Do not lubricate lock barrel with oil or grease, use CK dry powder graphite if necessary.

 In case of defects being detected please contact your nearest Castell Support Department for further actions. Please see Contact section for contact details.

 The interlock must be inspected every 6 months. Safety checks should include ensuring the keys can only be removed in the correct safety operating conditions (see page 1).

TECHNICAL DATA

Temperature rating	Minimum: -40°C [-40°F] ice free for Q & FS lock type
	Maximum: 107°C [224,6°F] for Q lock type/140°C [284°F] for FS lock type
Type of mounting	Surface mount using suitable fasteners (please refer to drawing on page 4 for more details)
Weight	Brass: 0.7 kg
	Stainless steel: 0.7 kg
Material	Brass/Stainless steel
B10d	2,500,000
Shock & vibration	EN 60068
PL rating	PLd

APPLICATION

The KSP bolt interlock safety component is used as part of an integrated safety system.

KSP bolt interlocks are used to allow safe locking of simple actuating mechanisms.

The bolt is held in the retract position by the mechanism, trapping the key. Whenever the aperture in the lever or mechanism is aligned, the bolt is permitted to extend using its internal spring action and will be locked in the extended position. The key can then be removed.

The key must be inserted and turned, retracting the bolt, to allow the actuating lever to be moved again.

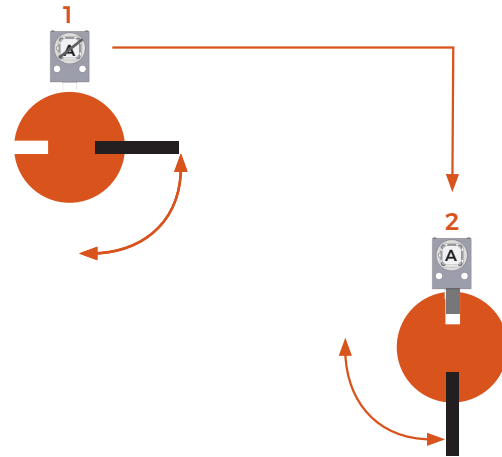

EC-DECLARATION

We, the manufacturers, declare that the components detailed herein and placed on the market comply with all the essential health and safety requirements applying to them.

ISO 13849-1:2015 Safety of Machinery

2006/42/EC Machinery Directive

Empowered signatory:

Kirstie Van Oerle
Business Unit Director



DRAWING

Dimensions: in mm

Note: For safe mounting, use security screws

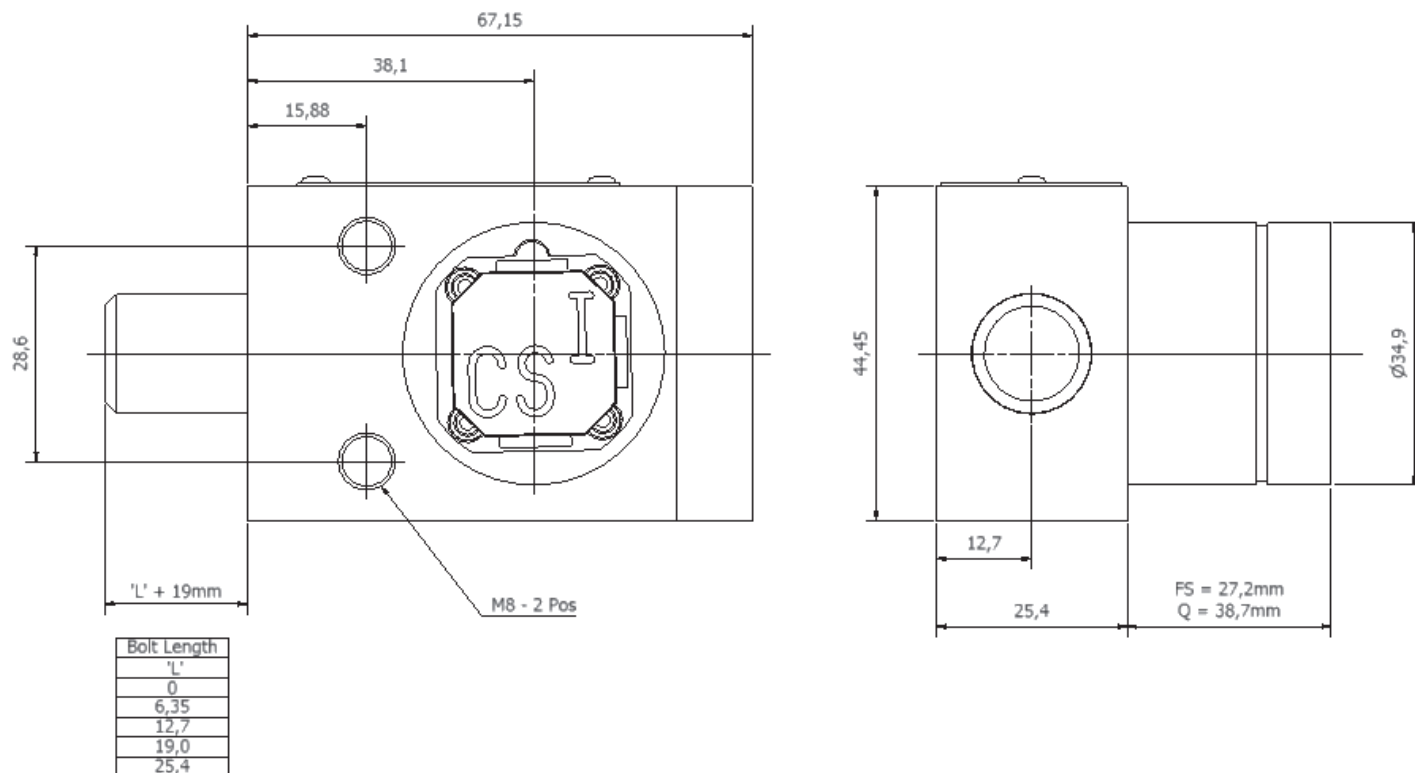

KSP, form 4





ORDER INFORMATION

	Component type	1	2	3	4	5
Part number	KSP					
Example	KSP	FS	B	0	1	ABC

1	Lock portion type	FS ⁽¹⁾ / Q ⁽¹⁾
2	Material	B = Brass / S = Stainless steel
3	L Dimension (bolt length when retracted) in mm	0 / 6.35 / 12.7 / 19 / 25.4
4	Form	1 / 2 / 3 / 4 ⁽²⁾
5	Lock portion symbol	FS ⁽¹⁾ up to 3 characters / Q ⁽¹⁾ up to 6 characters

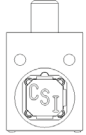
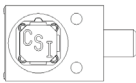
(1) FS - Lock type	Q - Lock type
Up to 3 characters	Up to 6 characters
	

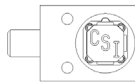
(2) Form			
1	2	3	4
			

Special construction available upon enquiry

ACCESSORIES

	Product	Part number
	Flip Cap	FLIP-S

CONTACT INFORMATION

Castell Safety

The Castell Building, 217 Kingsbury Road, London, NW9 9PQ UK
 t: +44 (0)20 8200 1200 | f: +44 (0)20 8205 0055 | e: sales@castell.com