

KLF Dual Key Bolt Interlock with Flange

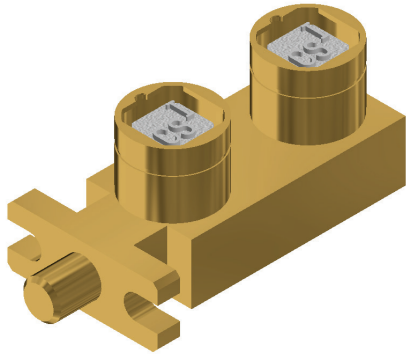

The KLF Lock is a multi-key operated mechanical bolt interlock for the control of electrical switchgear. The standard unit comes with a 16 mm diameter bolt of variable length, that is used to control the rotation or movement of operating handles or toggles of electrical switchgear. This lock is manufactured in brass or stainless steel. The KLF bolt interlock is available in a double key or exchange key condition.

OPERATION

The Castell KLF bolt interlock range is used on control of switchgear to inhibit movement of cams, toggles or levers.

KLF dual key bolt interlock, exchange key condition

- 1** Key A is free, while key B is trapped and bolt is extended.

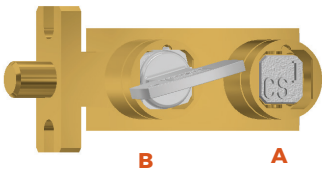

While the side bolt is extended and key B is trapped, key A is free. The disconnecter is locked by the extended bolt of the KLF.

- 2** Insert and turn key A, then turn key B to drive bolt, releasing key B.

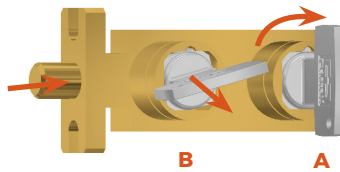

Inserting and turning key A in the bolt interlock enables rotation of key B, releasing the mechanism. This will trap key A into the lock.

- 3** Key B is free, key A is trapped and bolt is retracted.

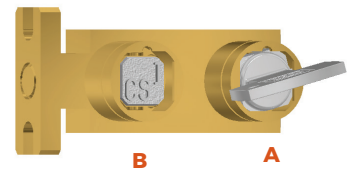

Key A stays trapped while the bolt is retracted and key B is released.

KLF dual key bolt interlock, double key condition

- 1** Key A and key B are free, bolt is extended.

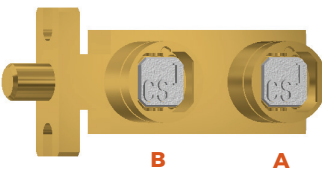

While the side bolt is extended, key A and key B are free. The disconnecter is locked.

- 2** Insert and turn both keys to drive bolt.

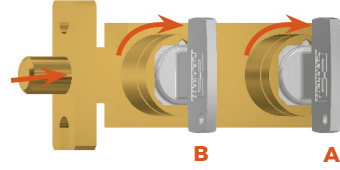

By inserting and turning key A and key B in the bolt interlock, the bolt can be retracted, releasing the disconnecter. This will trap both keys into the lock.

- 3** Keys are trapped, bolt is retracted.

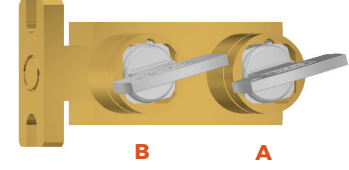

Both keys stay trapped while the bolt is retracted.

The length of the bolt can be varied to suit the application but travel of the bolt is always 19.05 mm. The key is free when the bolt is extended. Insertion and rotation clockwise of the key will retract the bolt. The key will be trapped in bolt retracted position.

USAGE





The KLF dual key bolt interlock should be used as a part of a safety system to allow safe control of disconnect switches.

-  The KLF bolt interlock is not designed for security purposes, such as access to a building. The KLF bolt interlock is not recommended to interlock gates or doors. Please refer to the AIE access interlock.

No hazardous substances were used in the manufacture of this product.

INSTALLATION



The housing of the KLF bolt interlock should normally be mounted to a panel using suitable fasteners. Please refer to drawing on page 4 for more installation details.

-  **IMPORTANT:** The interlock should be mounted using anti-tamper fasteners to prevent unauthorised removal.
-  The KLF bolt interlock must be installed by a competent and qualified person who has read and understood these instructions. Please retain this document in your technical file.
-  Force required to shear lock bolt is 30 KN for stainless steel and 19 KN for brass interlocks.
-  You must use M6 anti-tamper stainless steel screws secured using threadlock set to a torque of 5 N/M.
-  The manufacturer should be consulted when use in a corrosive environment is planned.

MAINTENANCE

Periodic visual checks should be carried out by the site manager / safety officer.

Do not lubricate lock barrel with oil or grease, use CK dry powder graphite if necessary.

-  In case of defects being detected please contact your nearest Castell Support Department for further actions. Please see Contact section for contact details.
-  The interlock must be inspected every 6 months. Safety checks should include ensuring the keys can only be removed in the correct safety operating conditions (see page 1).

TECHNICAL DATA

Temperature rating	Minimum: -40°C [-40°F] ice free for Q & FS lock type
	Maximum: 107°C [224,6°F] for Q lock type/140°C [284°F] for FS lock type
Type of mounting	Surface mount using suitable fasteners (please refer to drawing on page 4 for more details)
Weight	1.4 kg
Material	Brass/Stainless steel
B10d	2,500,000
Shock & vibration	EN 60068
PL rating	PLd

APPLICATION

KLF dual key bolt interlock safety component is used as a part of a safety system. A typical application is where the electrical and pneumatic supplies to the machine are switched on and the access doors to the hazardous area are locked closed.

Key A and B are trapped in the KLF bolt interlock, preventing access to the machine area. To enter the area, the pneumatic supply must be turned off. Turning the keys in the KLF bolt interlock will extend its bolt. The released keys ensure the bolt remains in extended position locking off the disconnecter.

The released keys can now be taken to the machine area to gain access via the AI access interlocks.

The disconnecter cannot be switched on until both access doors are locked closed and both keys replaced in the KLF bolt interlock.

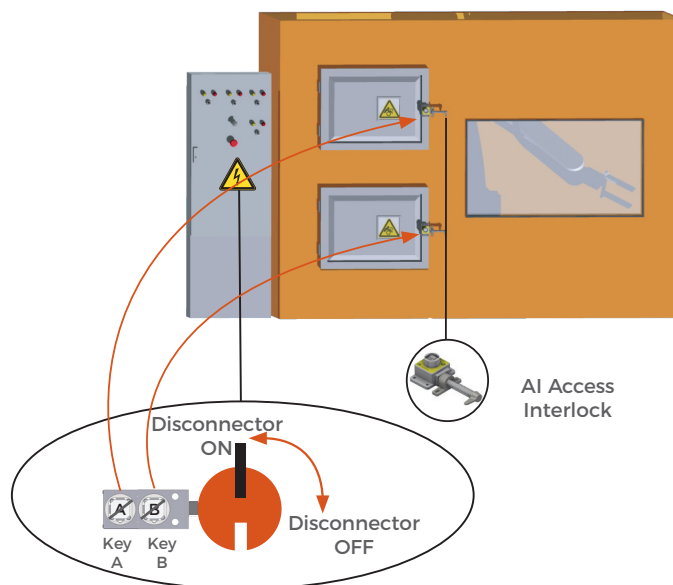

EC-DECLARATION

We, the manufacturers, declare that the components detailed herein and placed on the market comply with all the essential health and safety requirements applying to them.

ISO 13849-1:2015 Safety of Machinery

2006/42/EC Machinery Directive

Empowered signatory:

Kirstie Van Oerle
Business Unit Director



KLF Dual Key Bolt Interlock with Flange

DRAWING

Dimensions: in mm

Note: For safe mounting, use security screws

KLF, form 4

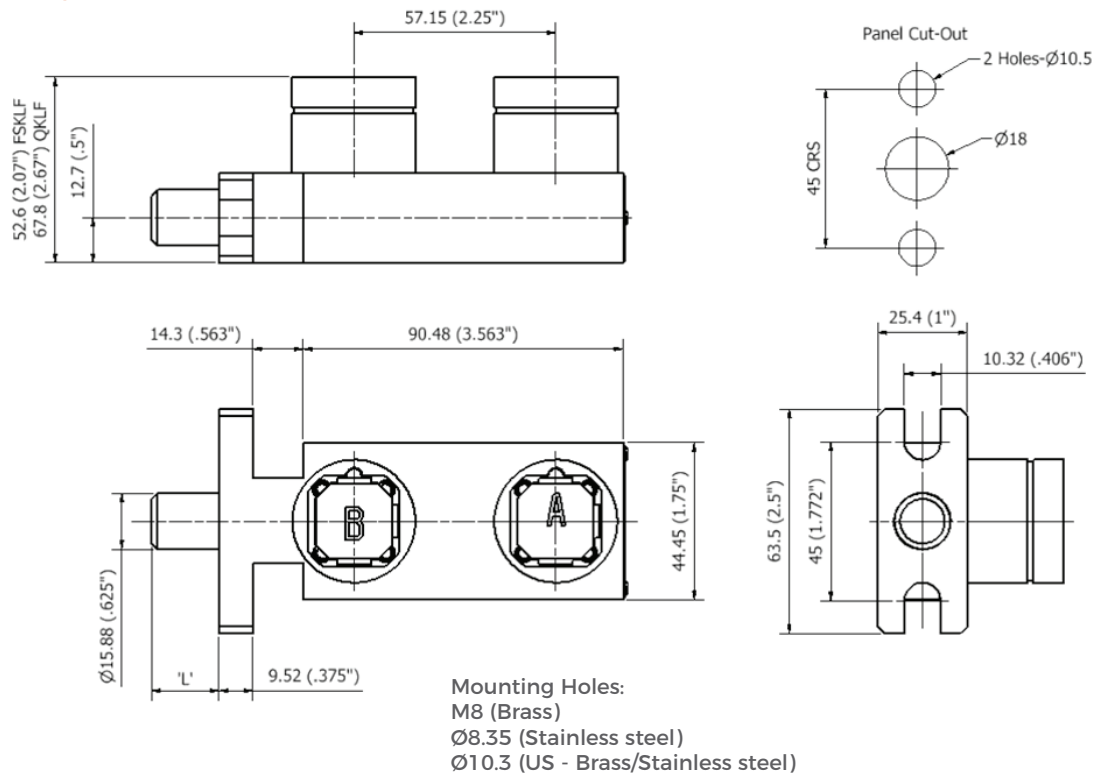

L Dimension Retracted bolt length (in mm)	Extended bolt length (in mm)
0	19.05
6.35	25.40
12.70	31.75
19.05	38.10
25.40	44.45

KLF Dual Key Bolt Interlock with Flange

ORDER INFORMATION

	Component type	1	2	3	4	5	6
Part number	KLF						
Example	KLF	FS	B	1S	6.4	1	D
		7	B Primary key symbol (double key condition)			8	A Secondary key symbol (double key condition)

1	Lock portion type	FS ⁽¹⁾ / Q ⁽¹⁾
2	Material	B = Brass / S = Stainless steel
3	Number of lock portions	1S = 1 secondary key (2 locks) 2S = 2 secondary keys (3 locks) 3S = 3 secondary keys (4 locks)
4	L dimension (bolt length when retracted) in mm	0 / 6.4 / 12.7 / 19.1 / 25.4
5	Form	1 / 2 / 3 / 4 ⁽²⁾
6	Key condition	D = double key condition / E = exchange key condition (see operation details, page 1)
7	Lock portion symbol: Primary key	FS ⁽¹⁾ up to 3 characters / Q ⁽¹⁾ up to 6 characters
8	Lock portion symbol: Secondary key(s)	FS ⁽¹⁾ up to 3 characters / Q ⁽¹⁾ up to 6 characters

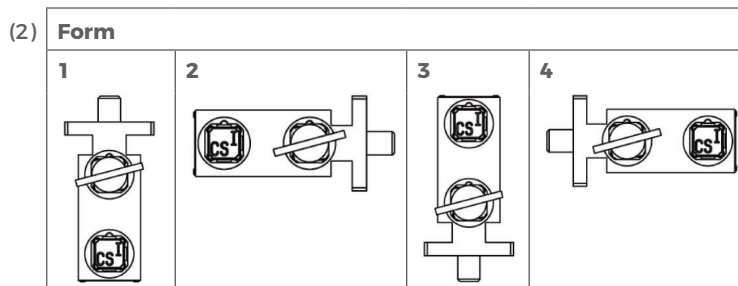
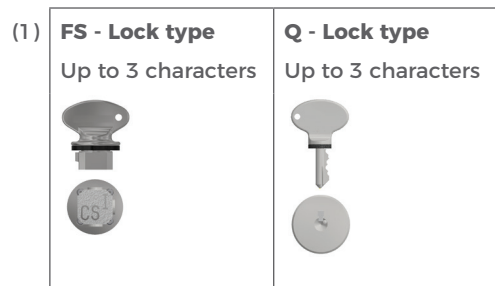

Special construction available upon enquiry

CONTACT INFORMATION

Castell Safety

The Castell Building, 217 Kingsbury Road, London, NW9 9PQ UK
 t: +44 (0)20 8200 1200 | f: +44 (0)20 8205 0055 | e: sales@castell.com