

KE Sliding Door Interlock

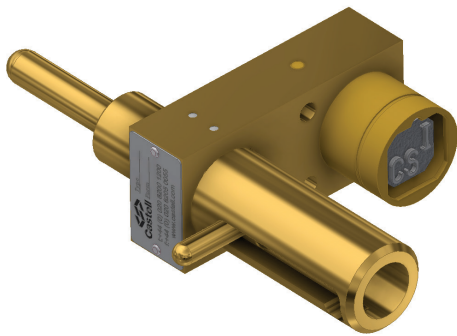

The KE lock is a one piece access interlock comprising of a main body and sliding bolt. The lock is designed to suit sliding doors of various sizes and thicknesses. The interlock is manufactured in brass and comes with the FS or Q lock type portions and is ideal for use in dry, non-corrosive environments where the lock is subject to medium to heavy use. Typical industries using the KE lock are automotive and steel production.

OPERATION

The Castell KE sliding door interlock range is used for sliding door applications.

KE sliding door lock, Form 2

1 Key is free, bolt is locked in extended

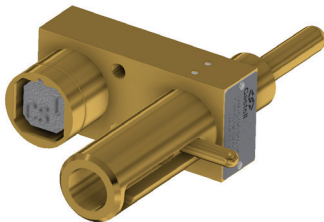

While the side bolt is extended, the key is free and usually held in the power isolation unit.

2 Insert and turn key to drive bolt

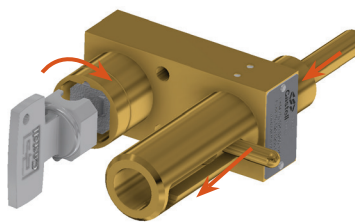

Inserting and turning the key in the KE door interlock allows the bolt guide to retract unlocking the access door to the machine area. This will trap the key in the lock.

3 Key is trapped, bolt is retracted

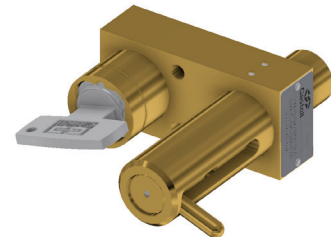

The key stays trapped while the bolt is retracted.

The length of the bolt is 50.8 mm. The key is free when the bolt is extended. Insertion and rotation clockwise of the key will retract the bolt. The key will be trapped in the bolt retracted position.

USAGE

The KE sliding door lock should be used to allow safe control of sliding doors.

 The KE lock is not designed for security purposes, such as external access to a building.

No hazardous substances were used in the manufacture of this product.

INSTALLATION

The housing of the KE sliding door lock should normally be mounted to a panel using suitable fasteners. See drawing on page 4 for more installation details.

 **IMPORTANT:** The interlock should be mounted using anti-tamper fasteners to prevent unauthorised removal.

 The KE sliding door lock must be installed by a competent and qualified person who has read and understood these instructions. Please retain this document in your technical file.

 You must use M6 anti-tamper stainless steel screws secured using threadlock set to a torque of 5 N/M.

 The manufacturer should be consulted when use in a corrosive environment is planned.

MAINTENANCE

Periodic visual checks should be carried out by the site manager / safety officer.

Do not lubricate lock barrel with oil or grease, use CK dry powder graphite if necessary.

 In case of defects being detected please contact your nearest Castell Support Department for further actions. Please see Contact section for contact details.

 The interlock must be inspected every 6 months. Safety checks should include ensuring the keys and lock bolt can only be operated in the correct safety operating conditions (see page 1).

TECHNICAL DATA

Temperature rating	Minimum: -40°C [-40°F] ice free for Q & FS lock type
	Maximum: 107°C [224.6°F] for Q lock type/140°C [284°F] for FS lock type
Type of mounting	Surface mount using suitable fasteners (please refer to drawing on page 4 for more details)
Weight	Brass: 0.7 kg
Material	Brass
B10d	2,500,000
Shock & vibration	EN 60068
PL rating	PLd

APPLICATION

The KE bolt interlock safety component is used as an integrated part of a safety system, typically in machine guarding applications.

The power supply to the system is switched on and the access door to the hazardous area is locked closed.

The removal of the isolation key in the KS20, isolates the electrical supply to the LV Panel. This key is then used to unlock the KE sliding door interlock on the sliding door.

The power cannot be switched on until the door is closed, the bolt is trapped in the KE sliding door interlock and the key is returned to the KS20.

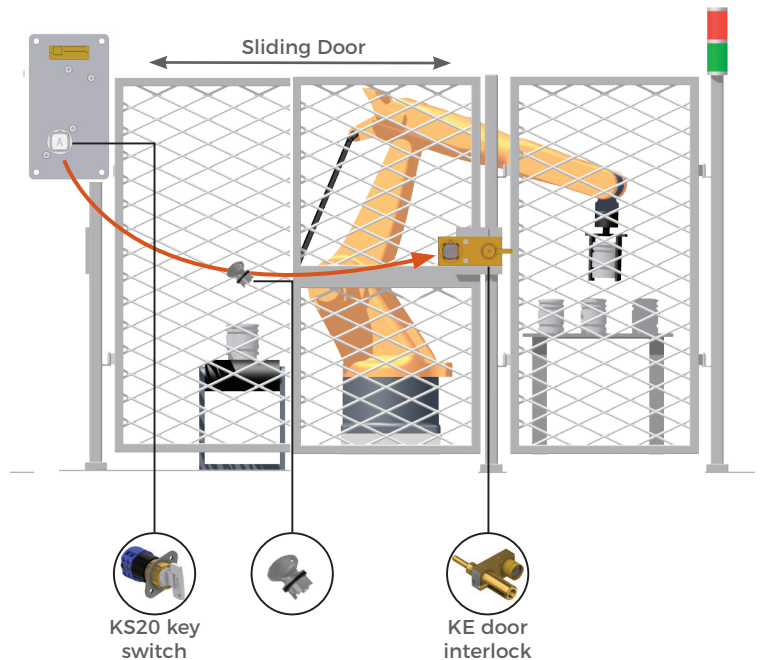

EC-DECLARATION

We, the manufacturers, declare that the components detailed herein and placed on the market comply with all the essential health and safety requirements applying to them.

ISO 13849-1:2015 Safety of Machinery

2006/42/EC Machinery Directive

Empowered signatory:

Kirstie Van Oerle
Business Unit Director 

KE Sliding Door Interlock

DRAWING

Dimensions: in mm

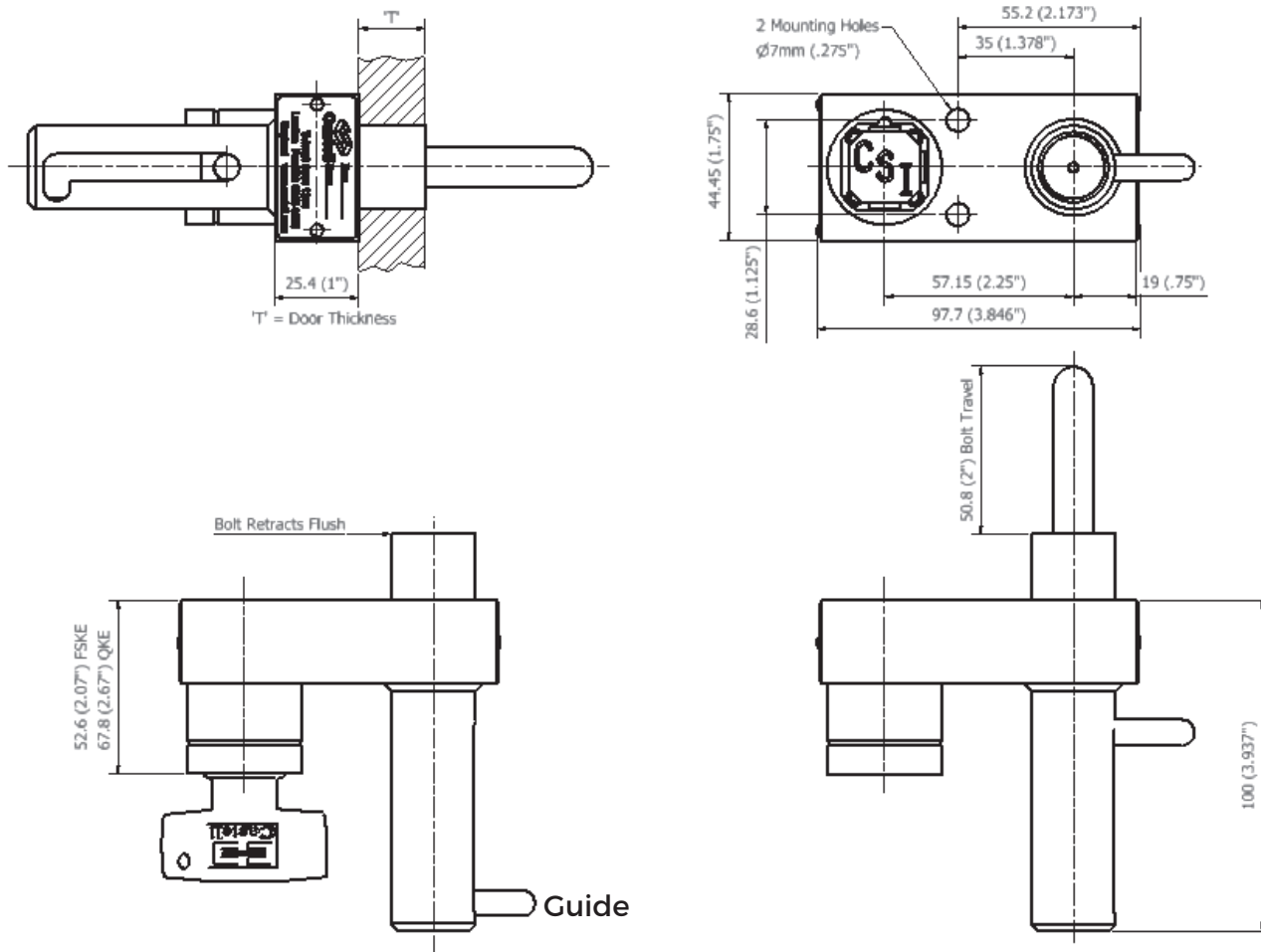

Note: For safe mounting, use security screws





ORDER INFORMATION

	Component type	1	2	3	4	5
Part number	KE					
Example	KE	FS	B	1	9 mm	ABC

1	Lock portion type	FS ⁽¹⁾ / Q ⁽¹⁾
2	Material	B = Brass (standard)
3	Form	1 / 2 / 3 / 4 ⁽²⁾
4	Door thickness	Please advise
5	Lock portion symbol	FS ⁽¹⁾ up to 3 characters / Q ⁽¹⁾ up to 6 characters

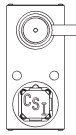
(1) FS - Lock type	Q - Lock type
Up to 3 characters	Up to 6 characters
	

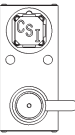
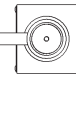
(2) Form			
1	2	3	4
			

Special construction available upon enquiry

ACCESSORIES

	Product	Part number
	Flip Cap	FLIP-S

CONTACT INFORMATION

Castell Safety

The Castell Building, 217 Kingsbury Road, London, NW9 9PQ UK
 t: +44 (0)20 8200 1200 | f: +44 (0)20 8205 0055 | e: sales@castell.com