

# AIS Access Interlock with Safety Switch

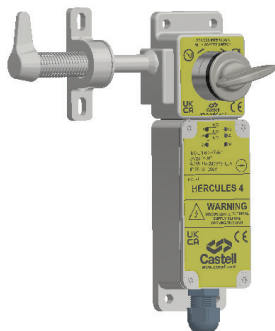

The AIS is a single key access interlock complete with electrical contacts for use on hinged doors. The AIS contacts can be used to switch off the machine via its control circuitry or to initialize a signal to visual beacons/sounders. The switch is sealed to IP65 with, 1N/O 2N/C contacts, rated to 10 A making it ideal for use in cross monitored safety systems. The interlock is manufactured in a durable stainless steel.

## OPERATION

The AIS Access Interlock with Safety Switch is used for machine isolation in order to protect the hazardous area from access while power is on.

### AIS Access Interlock with Safety Switch, bolt trapped - key trapped condition

- 1** Power is on, side bolt is trapped and key is trapped



While the power in the hazardous area is on, the side bolt of the AIS is trapped in the mechanism. The door is locked and the key is trapped.

- 2** Turn and release key, to change the switch contact condition and turn and release the bolt

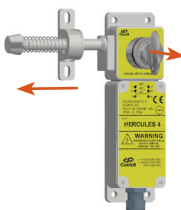

By turning and releasing the key, the contact condition changes switching the power off. The bolt can now be released. The key should be retained by the operator. As long as the door is open, the power cannot be turned on.

- 3** Power is off, bolt is free and key is free



With the side bolt and key released, the switch condition cannot be reversed.

### AIS Access Interlock with Safety Switch, bolt trapped - key free condition

- 1** Power is on, side bolt is trapped and key is free



While the power in the hazardous area is on, the side bolt of the AIS is trapped in the mechanism. The door is locked and the key is free.

- 2** Insert and turn the key, to change the switch contact condition and release the bolt

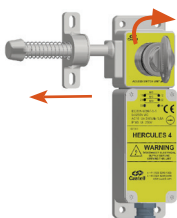

By inserting and turning the key, the contact condition changes switching the power off. The bolt can now be released. This will trap the key.

- 3** Power is off, bolt is free and key is trapped



With the side bolt released and key trapped, the switch condition cannot be reversed.

## USAGE

The AIS Access Interlock with Safety Switch is designed to be part of a safety system and is used to isolate the power which is then allows to gain access to a hazardous area.

 The AIS Access Interlock is not designed for security purposes, such as access to a building.

No hazardous substances were used in the manufacture of this product. The product can be disposed of in standard waste.

## INSTALLATION

The housing of the AIS access interlock with safety switch should normally be mounted on the static frame of the guard and the bolt to the hinged door using suitable fasteners. Fixed bolt bracket is highly tolerant to misaligned guards and should be fitted with suitable fasteners. Please refer to the drawing on page 4 for hole and mounting details. The AIS interlocks are available in Hand 1 and Hand 2 version suitable for left or right hinged doors, respectively. Anti vibration pads should be used on machines that generate a high level of vibration

 **IMPORTANT:** The AIS Access Interlock should be mounted on the guard using anti-tamper fasteners to prevent unauthorised removal.

 You must use M6 anti-tamper stainless steel screws secured using threadlock set to a torque of 5 N/M.

 Alignment limits of 0.5mm must be set in all planes. Angular displacement +/- 1° between lock and bolt.

 The AIS Access Interlock must be installed by a competent and qualified person who has read and understood these instructions. Please retain this document in your technical file.

 The manufacturer should be consulted when use in a corrosive environment is planned.

 Use middle strength threadlock on all four switch lid fixing screws and tighten to a torque of a 5 N/M to retain IP65 rating.

## MAINTENANCE

Periodic visual checks should be carried out by the site manager/safety officer.

Do not lubricate lock barrel with oil or grease, use CK dry powder graphite if necessary.

 The interlock must be inspected every 6 months. Safety checks should include ensuring the keys and lock bolt can only be removed in the correct safety operating conditions (see page 1).

 Check the limit switch is operating correctly with a continuity checker.

 In case of defects being detected please contact your nearest Castell Support Department for further actions. Please see Contact section for contact details.

## TECHNICAL DATA

<b>Temperature rating</b>	-30°C to 80°C
<b>Type of mounting</b>	Surface mount using M6 stainless steel anti-tamper fasteners
<b>Weight</b>	2.5 kg
<b>Material</b>	Stainless steel
<b>Control isolation</b>	10 A
<b>Motor isolation (AC Values)</b>	250V AC rated insulation voltage
<b>Switch approvals &amp; standards</b>	UL CSA EN60947-1 EN60947-5-1
<b>Operation</b>	Suitable for 1,000,000 operations
<b>B10d</b>	1,250,000
<b>Shock &amp; vibration</b>	In accordance with BS EN 60068-2-6 & BS EN 60068-2-27
<b>Conformity declaration</b>	CE
<b>Retention force</b>	3.4 KN
<b>Environment</b>	Suitable for IP65 rating
<b>PL rating</b>	PLd

## APPLICATION

The Castell AIS Access Interlock with Safety Switch is used as a part of an integrated safety system, typically in machine guarding applications.

The removal of the key from the AIS, isolates the electrical supply to the machine and allows the removal of the side bolt. Therefore the guard can only be opened when the electrical supply has been switched into a safe condition.

This key is then taken into the area by the operative to safeguard against accidental lock in or start up or to initialize another part of the process, i.e. switching the machine into teach mode.

The machine cannot be restarted until the door is closed, the bolt is trapped in the AIS Access Interlock and the key is replaced.

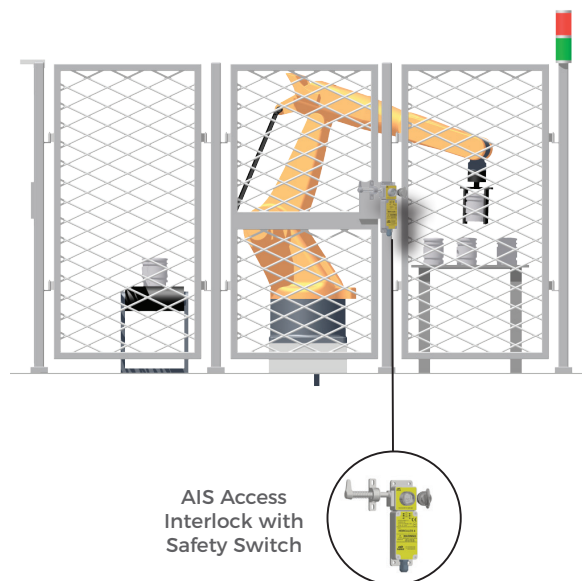

## EC-DECLARATION

We, the manufacturers, declare that the components detailed herein and placed on the market comply with all the essential health and safety requirements applying to them.

ISO 13849-1:2015 Safety of Machinery

2006/42/EC Machinery Directive

Empowered signatory:

Kirstie Van Oerle  
Business Unit Director



# AIS Access Interlock with Safety Switch

## DRAWING

Dimensions: in mm

**Note:** For safe mounting, use security screws

### AIS, Hand 1, key free - bolt trapped

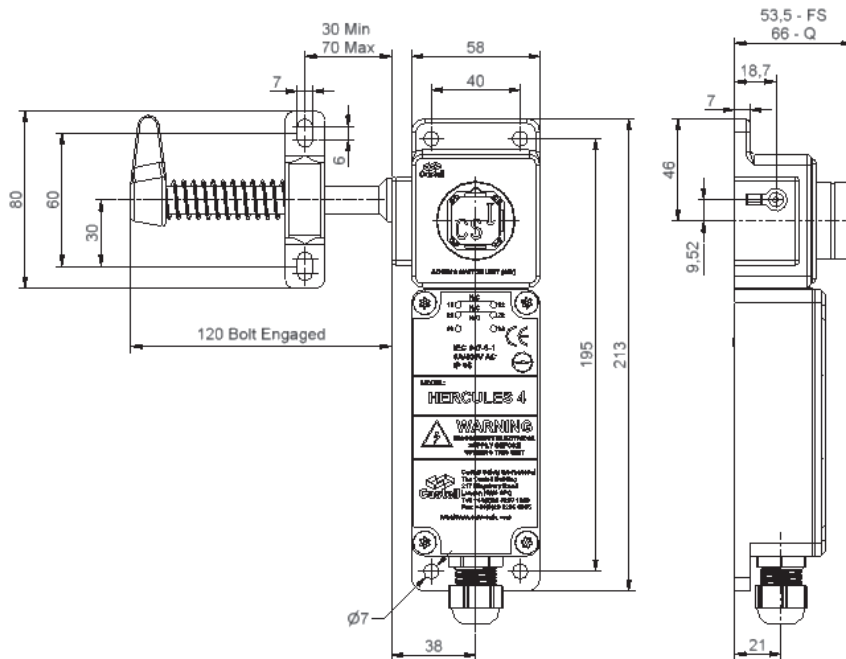

### AIS, Hand 2, key free - bolt trapped

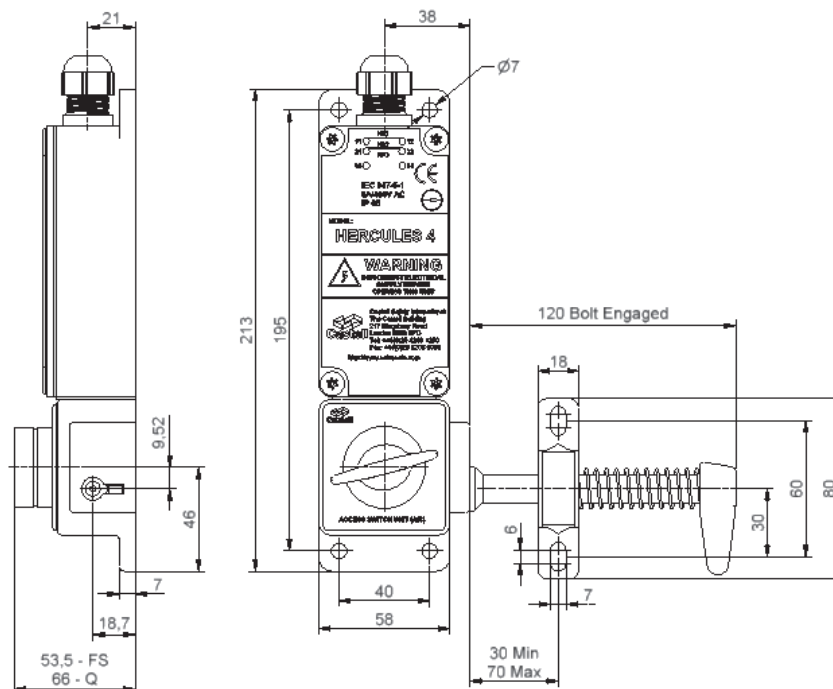

## WIRING DIAGRAM

Dimensions: in mm

**Note:** For safe mounting, use security screws

2 NC/1NO

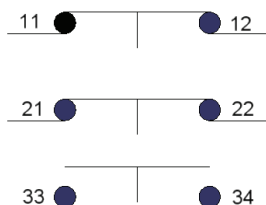

**Contacts as shown in the following positions:**

	Key	Bolt
Version 1 - KF	FREE	TRAPPED
Version 2 - KT	TRAPPED	TRAPPED

## ORDER INFORMATION

	<b>Component type</b>	<b>1</b>	<b>2</b>	<b>3</b>	<b>4</b>
Part number	AIS				
Example	AIS	FS	S	KT	1
	<b>5</b>	ABC			

<b>1</b>	<b>Lock portion type</b>	FS <sup>(1)</sup> / Q <sup>(1)</sup>
<b>2</b>	<b>Material</b>	S = Stainless steel (standard)
<b>3</b>	<b>Condition (by bolt trapped)</b>	KT = Key trapped while bolt trapped KF = Key free while bolt trapped
<b>4</b>	<b>Handing</b>	1 = Left hinged door (bolt enters left) <sup>(2)</sup> 2 = Right hinged door (bolt enters right) <sup>(2)</sup>
<b>5</b>	<b>Lock portion symbol</b>	FS <sup>(1)</sup> up to 3 characters / Q <sup>(1)</sup> up to 6 characters

(1) **FS - Lock type**  
Up to 3 characters



**Q - Lock type**  
Up to 6 characters



(2) **Handing**

**1**

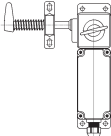

**2**

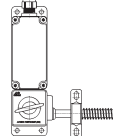

Special construction available upon enquiry

## ACCESSORIES

	<b>Product</b>	<b>Part number</b>
	Flip Cap	FLIP-S

## CONTACT INFORMATION

### Castell Safety

The Castell Building, 217 Kingsbury Road, London, NW9 9PQ UK  
 t: +44 (0)20 8200 1200 | f: +44 (0)20 8205 0055 | e: sales@castell.com