

The Castell PSBV pressure safe ball valve interlock is an integral valve interlock designed to enable locking off in either the open closed or in both conditions. The PSBV is supplied with a fitted high pressure mini 1/4" chrome plated brass ball valve. Fitting the PSBV enforces a logical, predetermined and safe sequence of operation where the control of flow paths is critical. The PSBV is manufactured in stainless steel with brass or stainless steel lock portions.

## OPERATION

Castell PSBV pressure safe ball valve interlocks are used to prevent unauthorised opening (or closing) of a line ensuring that the valve is always operated in a safe manner.

### PSBV pressure safe ball valve interlock **locked closed only condition**

- 1** Valve is normally locked closed, key is free

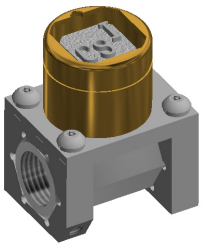

The service line is normally closed. The PSBV ball valve interlock locks the valve in the closed condition. The key is free.

- 2** Insert and turn key to unlock the valve

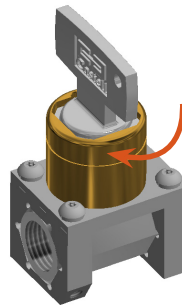

Inserting and turning the key in the PSBV releases the valve from being locked closed to open the line.

- 3** Valve is unlocked and opened, key is trapped

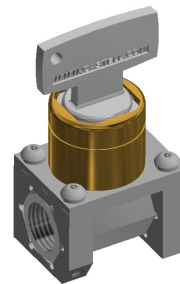

The key stays trapped while the valve is open.

### PSBV pressure safe ball valve interlock, **locked open only condition**

- 1** Valve is normally locked open

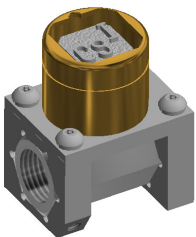

The service line is normally open. The PSBV ball valve interlock locks the valve in the open condition. The key is free.

- 2** Insert and turn key to unlock the valve

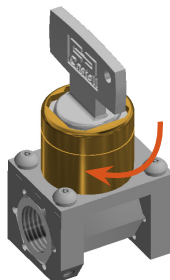

Inserting and turning the key in the PSBV, releases the valve from being locked open to close the line.

- 3** Valve is unlocked and closed, key is trapped

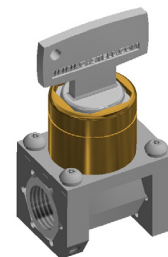

The key stays trapped while the valve is closed.

## USAGE

The PSBV Pressure safe ball valve interlock should be used to prevent unauthorised closing or opening of of lines.

 No hazardous substances were used in the manufacture of this product. The product can be disposed of in standard waste.

## INSTALLATION

Fitting the PSBV enforces a logical, predetermined and safe sequence of operation where the control of flow paths is critical.

PSBV interlocks are available in either the locked open or locked closed.

 The PSBV Pressure Safe Ball Valve Interlock must be installed by a competent and qualified person who has read and understood these instructions. Please retain this document in your technical file.

 The manufacturer should be consulted when use in a corrosive environment is planned.

## MAINTENANCE

Periodic visual checks should be carried out by the site manager/safety officer.

Do not lubricate lock barrel with oil or grease, use CK dry powder graphite if necessary.

 The interlock must be inspected every 6 months. Safety checks should include ensuring the keys can only be removed in the correct safety operating conditions (see page 1).

 In case of defects being detected please contact your nearest Castell Support Department for further actions. Please see Contact section for contact details.

## TECHNICAL DATA

<b>Temperature rating</b>	Minimum: -20°C [-4°F] ice free
	Maximum: 120°C [248°F]
<b>Type of mounting</b>	2 x M5 Mounting Holes
<b>Weight</b>	0.3 kg
<b>Material</b>	Stainless steel body with brass or stainless steel lock portions
<b>Valve Details</b> - Max. Pressure - Material - Fluid Application - Thread	30 bar (Kg/cm <sup>2</sup> ) non-shock cold working pressure Chrome Plated Drawn Brass Pneumatic, Sanitary, Water, Oil, Non-Aggressive Fluids G1/4 Pipe Thread (Female)
<b>B10d</b>	2,000,000
<b>Shock &amp; vibration</b>	In accordance with BS EN 60068-2-6 & BS EN 60068-2-27
<b>PL rating</b>	PLd

## APPLICATION

The PSBV is designed to operate as part of an integrated safety system controlling the operation of quarter turn ball valves in safety critical applications. The typical application of the PSBV pressure safe ball valve interlock is preventing unauthorised opening of one of the lines ensuring that one line is always closed.

PSBV interlock valves in both open and closed positions have an inter-changeable key between them ensuring that the first valve is closed before the second is open. While the operational line is opened, the service line is locked closed. Prior to opening the service line it needs to be ensured the operational line is locked closed. Turning and releasing key A locks the operating line valve in the closed condition. Key A can then be taken to the next valve which controls the service line. This valve can be unlocked and opened by inserting and turning key A in the PSBV.

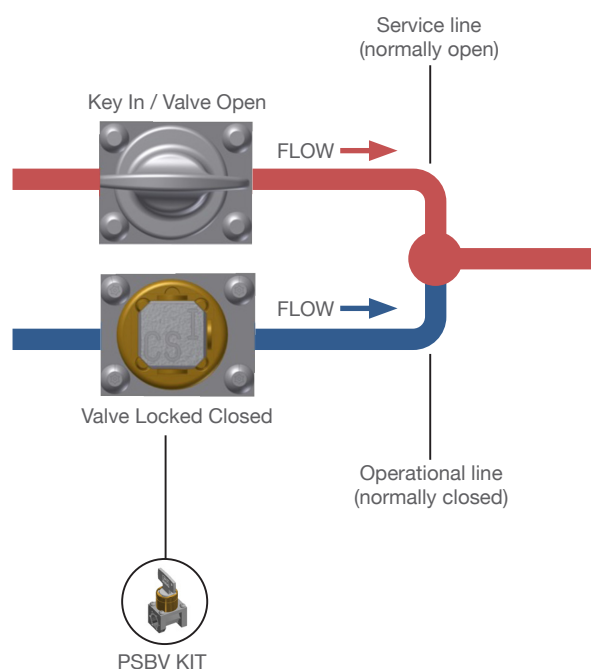

## EC-DECLARATION

We, the manufacturers, declare that the components detailed herein and placed on the market comply with all the essential health and safety requirements applying to them.

ISO 13849-1:2015 Safety of Machinery

2006/42/EC Machinery Directive

Empowered signatory:

Kirstie Van Oerle  
Business Unit Director 

## DRAWING

Dimensions: in mm

**Note:** For safe mounting, use security screws

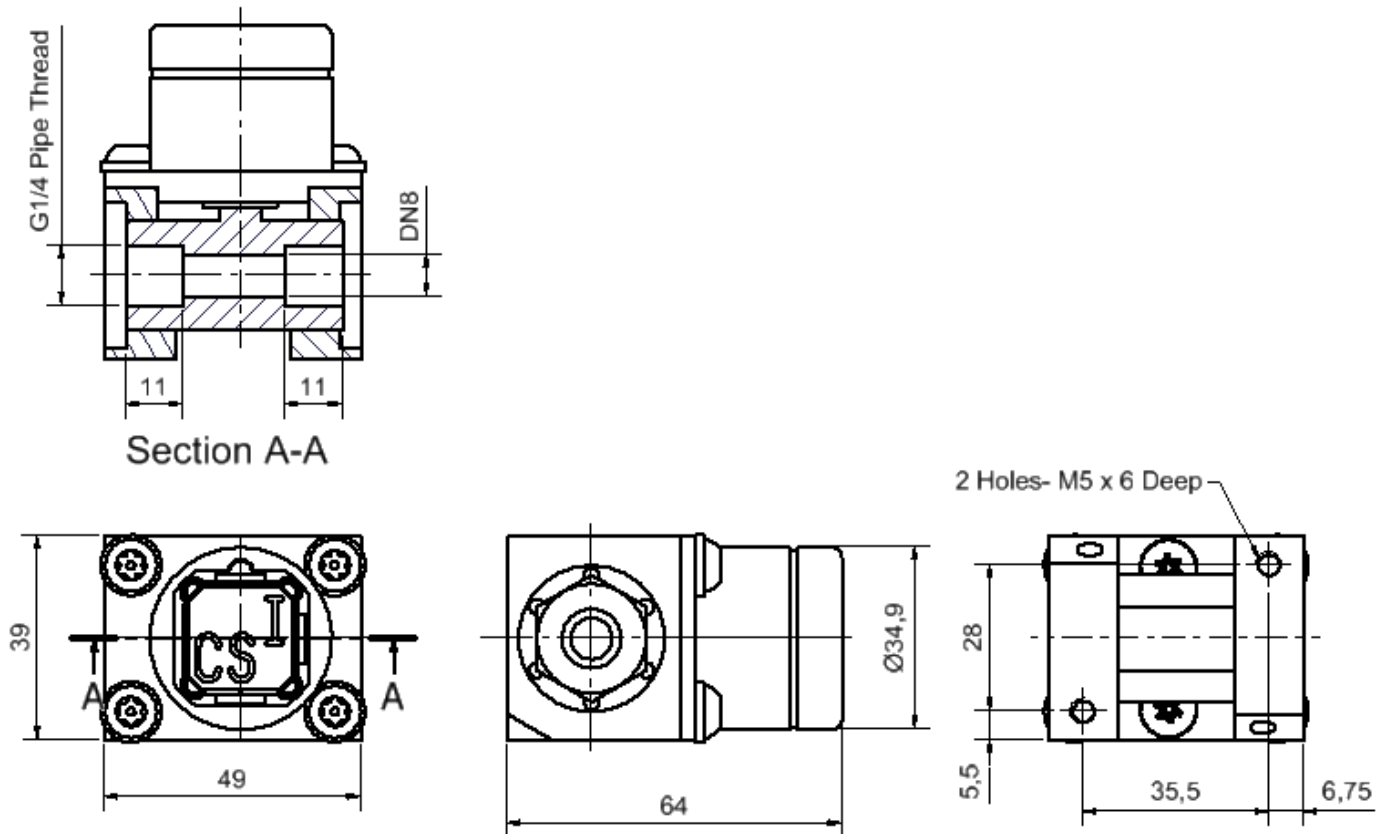

### PSBV, locked open position



## ORDER INFORMATION

	Component type	1	2	3	4
Part number	PSBV				
Example	PSBV	FS	B	LC	ABC

<b>1</b>	<b>Lock portion type</b>	FS <sup>(1)</sup> / Q <sup>(1)</sup>
<b>2</b>	<b>Material</b>	B = Brass S = Stainless steel
<b>3</b>	<b>Valve locked state</b>	LO = Locked open LC = Locked closed
<b>6</b>	<b>Lock portion symbol</b>	FS <sup>(1)</sup> up to 3 characters / Q <sup>(1)</sup> up to 6 characters

(1)	FS - Lock type	Q - Lock type
	Up to 3 characters	Up to 6 characters
		

Special construction available upon enquiry

## ACCESSORIES

	<b>Product</b>	<b>Part number</b>
	Flip Cap	FLIP-S

## CONTACT INFORMATION

### Castell Safety

The Castell Building  
217 Kingsbury Road  
London, NW9 9PQ  
UK

t: +44 (0)20 8200 1200  
f: +44 (0)20 8205 0055  
e: [sales@castell.com](mailto:sales@castell.com)

### Castell Safety

Tower 185  
60185 Frankfurt am Main  
Germany

t: +49 (0)69 50 50 47 310  
f: +49 (0)69 50 50 47 450  
e: [vertrieb@castell.com](mailto:vertrieb@castell.com)

### Kirk Key Interlock

9048 Meridian Circle NW  
North Canton, OH 47720  
USA

t: +1 800 438 2442  
f: +1 330 497 4400  
e: [sales@kirkkey.com](mailto:sales@kirkkey.com)

### SPS China

2F, Building 63  
No 421 Hongcao Road, Xuhui District  
Shanghai PRC, 200233  
China

t: +86 (0)21 6040 7398  
f: +86 (0)21 5453 0630  
e: [chinasales@castell.com](mailto:chinasales@castell.com)