

The KC Lock is a key operated mechanical bolt interlock suitable for the control of electrical switchgear. The standard unit comes with a 16 mm diameter bolt fitted with a claw, that is used to control the rotation or movement of the operating handles or toggles of electrical switchgear. The bolt length and claw dimensions are variable to suit the particular requirement. The lock is manufactured in brass or stainless steel.

## OPERATION

The Castell claw interlock range is used in switchgear control to lock off power supply and control accesses to hazardous areas.

### KC Claw Interlock, Form 4

- 1** Key is trapped, claw bolt is retracted. Switch is unlocked or in ON position.

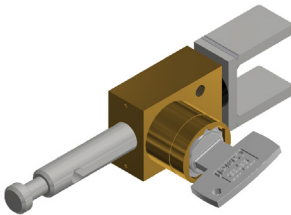

While the claw bolt is retracted, the switch is in ON position. The mechanism is unlocked while the key is trapped.

- 2** Extend the claw bolt. Then turn and release key to lock the claw in extended position and lock the switch OFF.

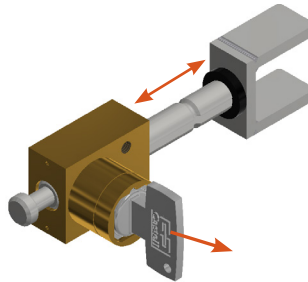

Extend the claw bolt manually and lock the claw in extended position by turning and releasing the key. This locks the switch in OFF position.

- 3** Key is free, claw bolt is extended and switch is locked OFF.

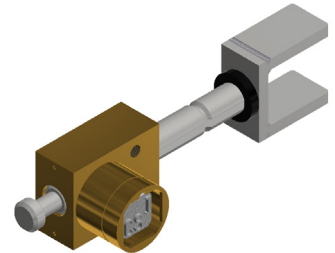

The released key can be used to access a hazardous area via an access interlock. The switch cannot be unlocked and switched on until the key is replaced and turned in the KC claw interlock.

The standard KC claw interlock comes with a 16mm diameter bolt fitted with a claw. The bolt length and claw dimensions are variable and need to be advised when ordering.

## USAGE

The KC claw interlock is designed to be part of a safety system and is used to lock off switches which then allows access to a hazardous area.

 The KC claw interlock is not designed for security purposes, such as access to a building.

No hazardous substances were used in the manufacture of this product.

## INSTALLATION

The housing of the KC claw interlock should normally be mounted to a panel using suitable fasteners (please refer to drawing on page 4 for more details).

 **IMPORTANT:** The interlock should be mounted using anti-tamper fasteners to prevent unauthorised removal.

 The KC claw interlock must be installed by a competent and qualified person who has read and understood these instructions. Please retain this document in your technical file.

 You must use M6 anti-tamper stainless steel screws secured using threadlock set to a torque of 5 N/M.

 The manufacturer should be consulted when use in a corrosive environment is planned.

## MAINTENANCE

Periodic visual checks should be carried out by the site manager / safety officer.

Do not lubricate lock barrel with oil or grease, use CK dry powder graphite if necessary.

 In case of defects being detected please contact your nearest Castell Support Department for further actions. Please see Contact section for contact details.

 The interlock must be inspected every 6 months. Safety checks should include ensuring the keys and lock bolt can only be removed in the correct safety operating conditions (see page 1).

## TECHNICAL DATA

<b>Temperature rating</b>	Minimum: -40°C [-40°F] ice free for Q & FS lock type
	Maximum: 107°C [224.6°F] for Q lock type/140°C [284°F] for FS lock type
<b>Type of mounting</b>	Surface mount using suitable fasteners (please refer to drawing on page 4 for more details)
<b>Weight</b>	N/A
<b>Material</b>	Brass/Stainless steel
<b>B10d</b>	2,500,000
<b>Shock &amp; vibration</b>	In accordance with BS EN 50155
<b>PL rating</b>	PLd

## APPLICATION

The Castell KC claw interlock safety component is used as part of an integrated safety system, typically in machine guarding applications. It is usually used in combination with an access interlock such as the AI for part body access or AIE with an exchange key for full body access control.

The power supply is switched on and the key is trapped in KC Lock. To remove the key the isolator is turned to the off position and the bolt manually extended. The key is then released, locking the isolator off. The key can then be used to open an AI access lock on a HV cabinet.

The system has to be designed so that the bolt of the KC claw interlock cannot be retracted to unlock the power supply until the door to the HV cabinet is locked, the key is removed from AI access lock and replaced into the KL claw interlock.

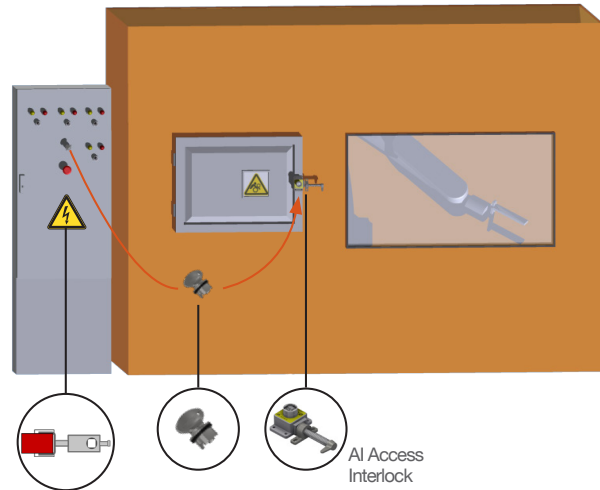

KC claw interlock:  
Switch locked OFF (bolt extended), key released

## EC-DECLARATION

We, the manufacturers, declare that the components detailed herein and placed on the market comply with all the essential health and safety requirements applying to them.

ISO 13849-1:2015 Safety of Machinery

2006/42/EC Machinery Directive

Empowered signatory:

Kirstie Van Oerle  
Business Unit Director 

## DRAWING

Dimensions: in mm

**Note:** For safe mounting, use security screws

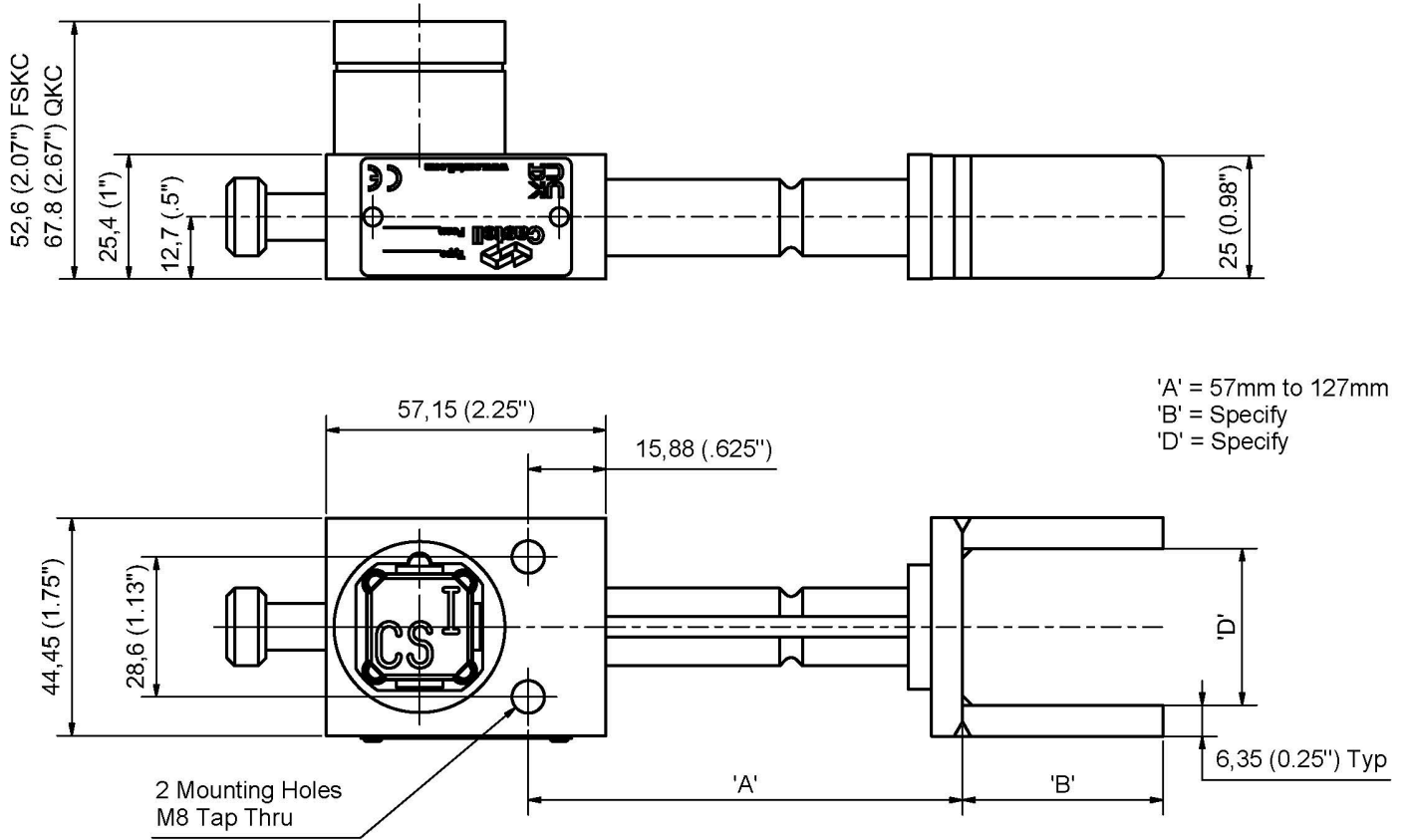



## ORDER INFORMATION

	<b>Component type</b>	<b>1</b>	<b>2</b>	<b>3</b>
Part number	KC			
Example	KC	FS	B	4

<b>4</b>	90 mm	A dimension (A dimension needs to be 30 mm greater than B dimension)
<b>5</b>	60 mm	B dimension
<b>6</b>	28.9 mm	D dimension
<b>7</b>	ABC	Lock portion symbol

<b>1</b>	Lock portion type	FS <sup>(1)</sup> / Q <sup>(1)</sup>
<b>2</b>	Material	B = Brass / S = Stainless steel
<b>3</b>	Form	1 / 2 / 3 / 4 <sup>(2)</sup>
<b>4</b>	A dimension (bolt travel)	Please specify: from 57 mm to 127 mm
<b>5</b>	B dimension (see page 4 for claw details)	Please specify
<b>6</b>	D dimension (see page 4 for claw details)	Please specify
<b>7</b>	Lock portion symbol	FS <sup>(1)</sup> up to 3 characters / Q <sup>(1)</sup> up to 6 characters

(1) <b>FS - Lock type</b> Up to 3 characters	<b>Q - Lock type</b> Up to 6 characters
	

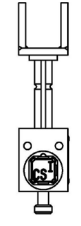
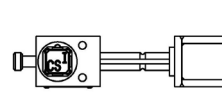
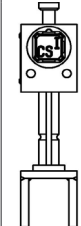
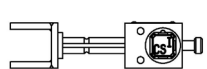
(2) <b>Form</b>			
<b>1</b>	<b>2</b>	<b>3</b>	<b>4</b>
			

Special construction available upon enquiry

## CONTACT INFORMATION

**Castell Safety**  
The Castell Building  
217 Kingsbury Road  
London, NW9 9PQ  
UK  
t: +44 (0)20 8200 1200  
f: +44 (0)20 8205 0055  
e: [sales@castell.com](mailto:sales@castell.com)

**Castell Safety**  
Tower 185  
60185 Frankfurt am Main  
Germany  
t: +49 (0)69 50 50 47 310  
f: +49 (0)69 50 50 47 450  
e: [vertrieb@castell.com](mailto:vertrieb@castell.com)

**Kirk Key Interlock**  
9048 Meridian Circle NW  
North Canton, OH 47720  
USA  
t: +1 800 438 2442  
f: +1 330 497 4400  
e: [sales@kirkkey.com](mailto:sales@kirkkey.com)

**SPS China**  
2F, Building 63  
No 421 Hongcao Road, Xuhui District  
Shanghai PRC, 200233  
China  
t: +86 (0)21 6040 7398  
f: +86 (0)21 5453 0630  
e: [chinasales@castell.com](mailto:chinasales@castell.com)