

D Panel Door Interlock



The D type lock is a two-part interlock, comprising of a lock body and rear or front entry mounted catch. Typically, the D lock is used for interlocking electrical control cubicles and distribution panels. It is also suitable for use on light access doors or hatches. The catch is available in two options, one suited to well aligned doors, the other suited to misaligned doors. The D lock is available as FS (figure symbol) or Q lock type.

OPERATION

The D lock range is used for interlocking electrical control cubicles and distribution panels.

D Panel Door Interlock, Form 2

1 Key is free, catch is trapped



While the catch is trapped, the key is free. The mechanism is locked keeping the door locked closed.

2 Insert and turn key to release catch

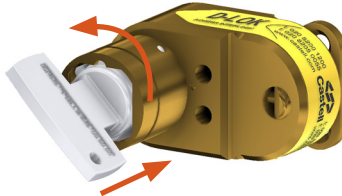

By inserting and turning the key in the D lock, you can release the catch. This will trap the key into the lock.

3 Key is trapped, catch is free



The key remains trapped while the catch is released and the door is opened.

The D panel door interlock is available with rear or front entry mounted catch.

There are two catch types, standard for well aligned doors and MS catch for misaligned doors.

USAGE

The D Panel Door Interlock should be used for interlocking electrical control cubicles and distribution panels.



The D Lock is not designed for security purposes, such as external access to a building.

No hazardous substances were used in the manufacture of this product.

INSTALLATION

The housing of the D Panel Door Interlock should normally be mounted to a panel using suitable fasteners (please refer to drawing on page 4 for more details)



IMPORTANT: The interlock should be mounted using anti-tamper fasteners to prevent unauthorised removal.



The D Panel Door Interlock must be installed by a competent and qualified person who has read and understood these instructions. Please retain this document in your technical file.



The manufacturer should be consulted when use in a corrosive environment is planned.



Alignment limits of 0.5 mm must be set in all planes. Angular displacement $\pm 1^\circ$ between lock and catch.

MAINTENANCE

Periodic visual checks should be carried out by the site manager / safety officer.

Do not lubricate lock barrel with oil or grease, use CK dry powder graphite if necessary.



In case of defects being detected please contact your nearest Castell Support Department for further actions. Please see Contact section for contact details.



The interlock must be inspected every 6 months. Safety checks should include ensuring the keys can only be removed in the correct safety operating conditions (see page 1).

TECHNICAL DATA

Temperature rating	Minimum: -40°C [-40°F] ice free for Q & FS lock type
	Maximum: 107°C [224.6°F] for Q lock type/140°C [284°F] for FS lock type
Type of mounting	Surface mount using suitable fasteners (please refer to drawing on page 4 for more details)
Weight	1 kg
Material	Brass/Stainless steel
Shock & vibration	In accordance with BS EN 50155 & IEC 61373
PL rating	PLd
B10d	2,000,000

APPLICATION

The D Lock safety component is used as part of an integrated safety system.

The power supply to the system is switched on and the access doors to the hazardous area are locked closed.

The removal of the isolation key in the KSS20, isolates the electrical supply to the LV Panel. This key is then used to unlock the D door interlock on the panel door.

The power cannot be switched on until the door is closed, the catch is trapped in the D panel door interlock and the key returned to the KSS20.

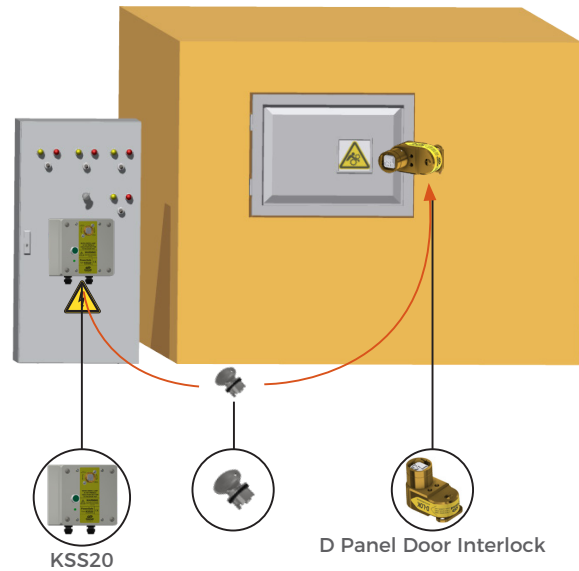

EC-DECLARATION

We, the manufacturers, declare that the components detailed herein and placed on the market comply with all the essential health and safety requirements applying to them.

ISO 13849-1:2015 Safety of Machinery

2006/42/EC Machinery Directive

Empowered signatory:

Kirstie Van Oerle
Business Unit Director 

D Panel Door Interlock

DRAWING

Dimensions: in mm

Note: For safe mounting, use security screws

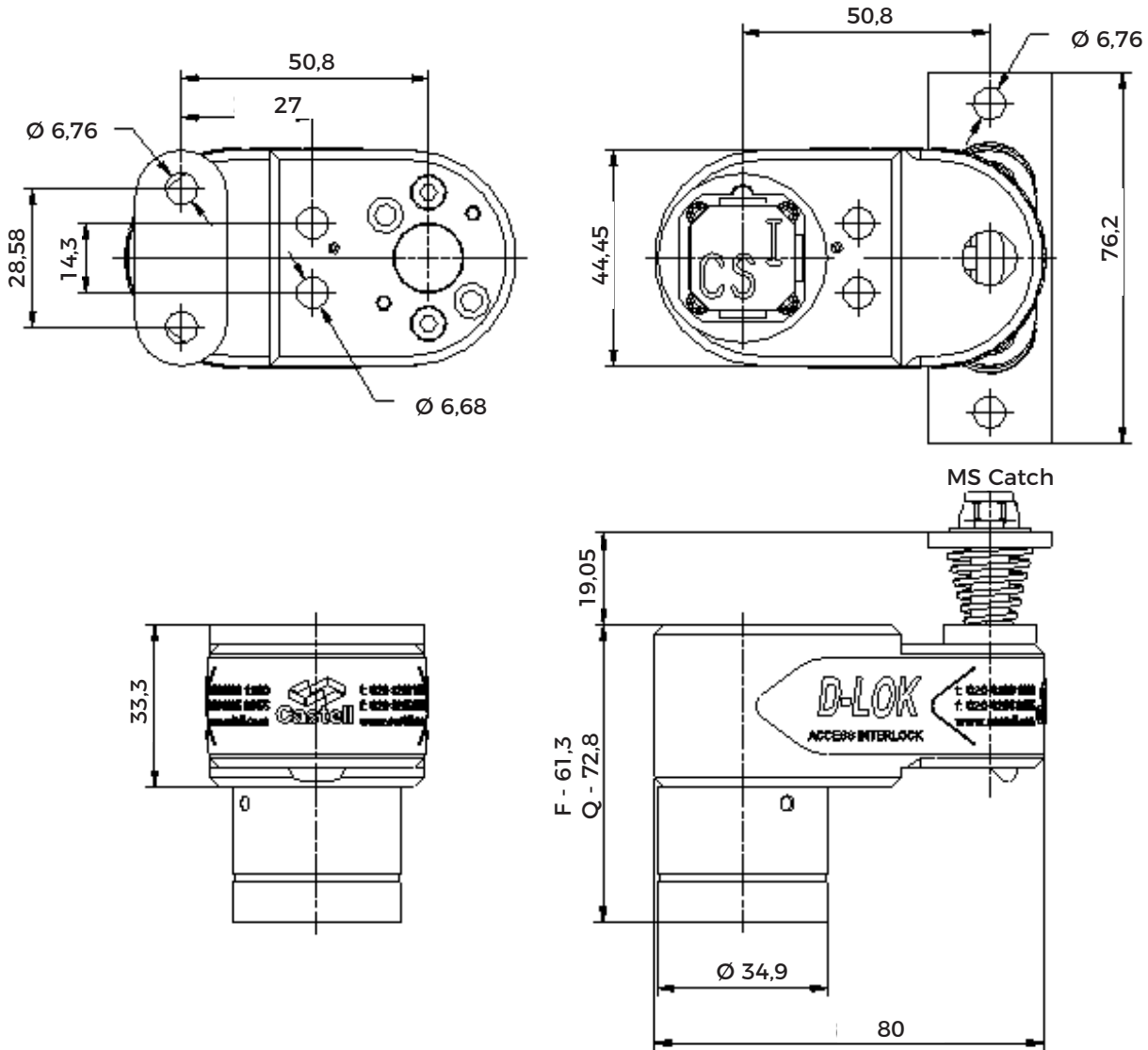

ORDER INFORMATION

	Component type	1	2	3	4	5	6
Part number	D						
Example	D	FS	B	RE	STD	1	ABC

1	Lock type	FS ⁽¹⁾ / Q ⁽¹⁾
2	Material	B = Brass / S = Stainless steel
3	Catch entry	RE = Rear entry / FR = Front entry
4	Catch type	STD = standard catch, use for well aligned doors / MS = catch with spring, use for misaligned doors
5	Form	1 / 2 / 3 / 4 ⁽²⁾
6	Lock portion symbol	FS ⁽¹⁾ up to 3 characters / Q ⁽¹⁾ up to 6 characters

(1) **FS - Lock type**
Up to 3 characters



Q - Lock type
Up to 6 characters



(2) **Form**

1



2

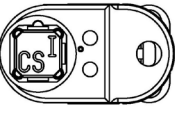

3

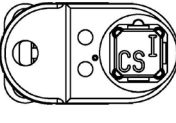

4



Special construction available upon enquiry

ACCESSORIES

	Product	Part number
	Flip Cap	FLIP-S

CONTACT INFORMATION

<p>Castell Safety The Castell Building 217 Kingsbury Road London, NW9 9PQ UK t: +44 (0)20 8200 1200 f: +44 (0)20 8205 0055 e: sales@castell.com</p>	<p>Castell Safety Tower 185 60185 Frankfurt am Main Germany t: +49 (0)69 50 50 47 310 f: +49 (0)69 50 50 47 450 e: vertrieb@castell.com</p>	<p>Kirk Key Interlock 9048 Meridian Circle NW North Canton, OH 47720 USA t: +1 800 438 2442 f: +1 330 497 4400 e: sales@kirkkey.com</p>	<p>SPS China 2F, Building 63 No 421 Hongcao Road, Xuhui District Shanghai PRC, 200233 China t: +86 (0)21 6040 7398 f: +86 (0)21 5453 0630 e: chinasales@castell.com</p>
--	--	--	--