

AIE Dual Key Access Interlock

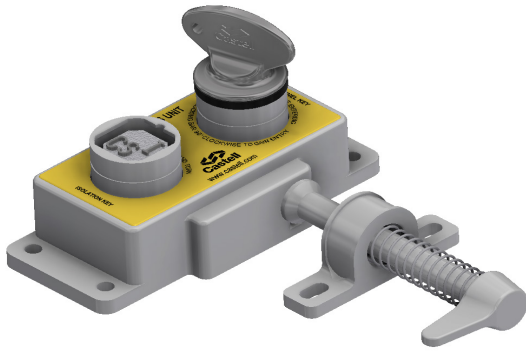

The AIE dual key access interlock is suitable for use on hinged and sliding doors. The interlock has an open cavity design and is manufactured in an aluminium alloy or durable stainless steel. The AIE is available in two options: exchange key and double key.

OPERATION

Castell dual key access interlocks are used in various applications to control full body access to hazardous areas.

AIE dual key access interlock, exchange key condition (bolt trapped - personnel key trapped/isolation key free)

1 Side bolt is trapped and the personnel key is trapped, isolation key is free.



While the door is closed, the isolation key is free, the personnel key trapped in the AIE, and the bolt of the AIE is trapped in the mechanism.

2 Insert and turn isolation key, then turn and release the personnel key. The side bolt may now be released.

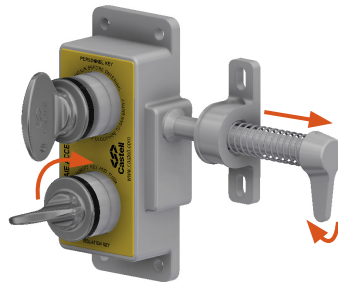

By inserting and turning the isolation key in the AIE, the personnel key can be turned and released. This traps the isolation key, which enables the release of the side bolt. The personnel key should be returned by the operator while in the hazardous area.

3 Isolation key is trapped, the side bolt and personnel key are free.



The isolation key stays trapped while the bolt is released and the door is open.

AIE dual key access interlock, double key condition (bolt trapped - both keys are free)

1 Bolt is trapped, while both keys are free.



While both keys are free, the bolt of the AIE is trapped in the mechanism. The door is locked.

2 Insert and turn the keys, then turn and release bolt.

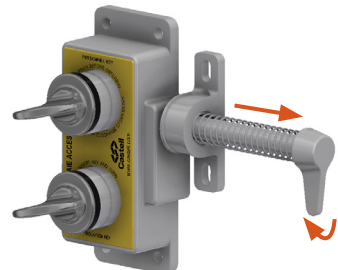

By inserting and turning the keys in the AIE, the bolt is released by turning, and the door can be opened.

3 Keys are trapped, bolt is unlocked.



Both keys stay trapped while the bolt is released and the door is opened.

USAGE

The AIE access interlock should be used to allow safe access to potential hazardous and dangerous areas.

The AIE access interlock should be used on full body access doors where the use of personal safety keys is essential (to prevent accidental lock in and or start up).

 The AIE access interlock is not designed for security purposes, such as a safe.

No hazardous substances were used in the manufacture of this product. The product can be disposed of in standard waste.

INSTALLATION

The housing of the AIE access interlock should normally be mounted on the static frame of the guard and the bolt to the sliding or hinged door using suitable fasteners. Fixed bolt bracket is highly tolerant to misaligned guards and should be fitted with suitable fasteners. Please refer to the drawing on page 4 for mounting details for the housing and bolt. The AIE interlocks are available in Hand 1 and Hand 2 version suitable for left or right hinged doors, respectively. Anti vibration pads should be used on machines that generate a high level of vibration.

 **IMPORTANT:** The AIE access interlock should be mounted on the guard using anti-tamper fasteners to prevent unauthorised removal.

 The AIE access interlock must be installed by a competent and qualified person who has read and understood these instructions. Please retain this document in your technical file.

 You must use M6 anti-tamper stainless steel screws secured using threadlock set to a torque of 5 N/M.

 Alignment limits of 0.5 mm must be set in all planes. Angular displacement +/- 1° between lock and bolt.

 The manufacturer should be consulted when use in a corrosive environment is planned.

 Use middle strength threadlock on all four switch lid fixing screws and tighten to a torque of 5 N/M to retain IP 65 rating.

MAINTENANCE

Periodic visual checks should be carried out by the site manager/safety officer.

Do not lubricate lock barrel with oil or grease, use CK Dry Powder Graphite if necessary.

 The interlock must be inspected every 6 months. Safety checks should include ensuring the keys and lock bolt can only be removed in the correct safety operating conditions. (see page 1)

 In case of defects being detected please contact your nearest Castell Support Department for further actions. Please see Contact section for contact details.

TECHNICAL DATA

Temperature rating	Minimum: -40°C [-40°F] ice free for Q & FS lock type
	Maximum: 107°C [224.6°F] for Q lock type/140°C [284°F] for FS lock type or 288°C [550°F] upon request
Type of mounting	Surface mount using M6 stainless steel anti-tamper fasteners
Weight	Brass: 0.8 kg
	Stainless steel: 1.0 kg
Material	Aluminium alloy/brass or stainless steel
MTTF Certification	Available on request
Operation	Suitable for 1,000,000 operations
B10d	1,250,000
Retention force	3.4 KN
Shock & vibration	In accordance with BS EN 50155 & IEC 61373
PL rating	PLd

APPLICATION

A typical application of the AIE dual key Access Interlock is machine guarding with full body access.

The AIE safety component is used as part of an integrated safety system, which ensures a machine is shut down, before access to the hazardous area is allowed.

This system involves a KS key switch for the electrical supply. The removal of the isolation key from the key switch isolates the electrical supply to the machine.

This key is taken to the AIE and inserted into the isolation lock. This allows the release of the personnel key and then the sidebolt, which traps the isolation key. The personnel key is then taken into the area by the operative to safeguard themselves against accidental lock in and start up.

The machine cannot be restarted until the personnel key is returned, the bolt is replaced in the AIE and the isolation key is removed and taken to the KS key switch.

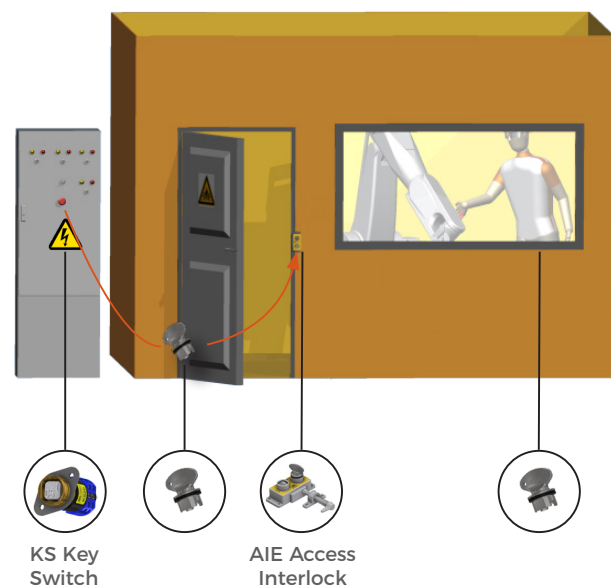

EC-DECLARATION

We, the manufacturers, declare that the components detailed herein and placed on the market comply with all the essential health and safety requirements applying to them.

ISO 13849-1:2015 Safety of Machinery

2006/42/EC Machinery Directive

Empowered signatory:

Kirstie Van Oerle
Business Unit Director



AIE Dual Key Access Interlock

DRAWING

Dimensions: in mm

Note: For safe mounting, use security screws

AIE, Hand 1

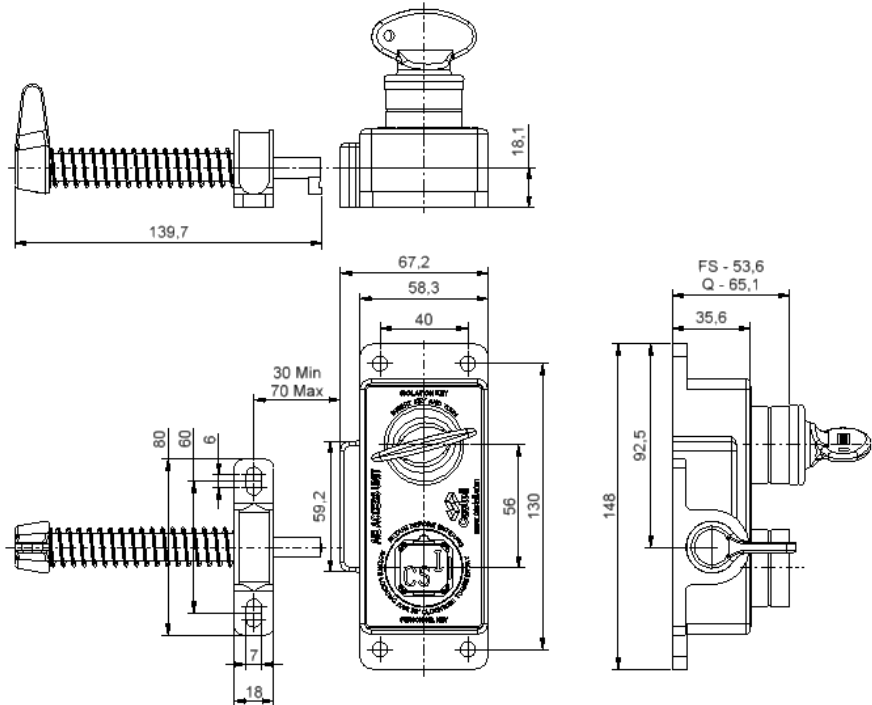

AIE, Hand 2

